

iNELS
Wireless electro-installation





ELKO EP

ELKO EP have been your partner in the field for 30 years, developing and manufacturing the highest quality electronic devices for electroinstallation as well as smart system for residential and building automation.

ELKO EP employs more than 350 people across 15 foreign branches and exports its products to more than seventy countries. Company of the Year, Visionary of the Year, Superbrands and Global Exporter of the Year are just some of the awards we have received throughout the years as we consistently strive to move forward in the field of innovation and development.

Millions of relays, thousands of smart homes, hundreds of buildings and many satisfied customers - This is ELKO EP; a traditional company based in the center of Europe, where own development, production, logistics, and service are at the forefront of our focus.

Facts & stats

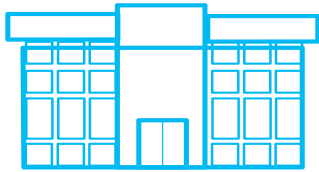

30 %

Czech

40 %

export

30 %

branches



WORLDWIDE

11 branches
3 franchises
70 export countries

350

employees
in holding

30 000 +

iNELS
installations

30 000 000 +

manufactured
products

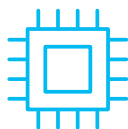

R&D

continuously
innovative

MANUFACTURER

fully automated
complete proces

SUPPORT

24 / 7 / 365

World leader
in DIN rail relays production

System scalability

UNITS

Individual elements of the iNELS system for personalised installation.

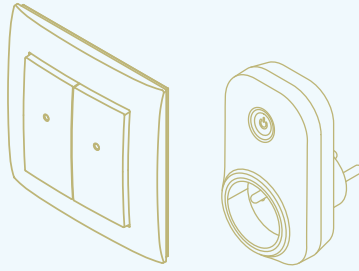

KITS

Pre-Set elements for everyday applications.

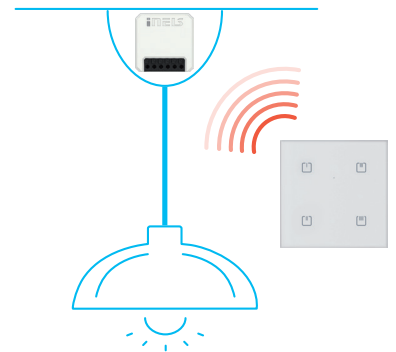
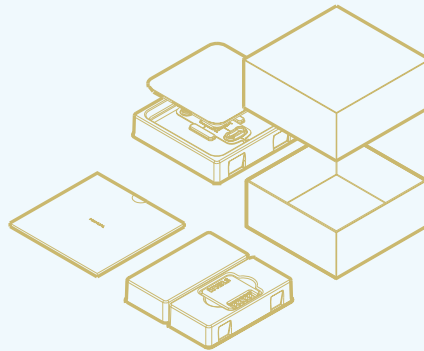
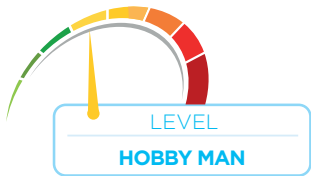

CONNECTED HOME

A simple solution to turn your house into a smart home, without any structural intervention.

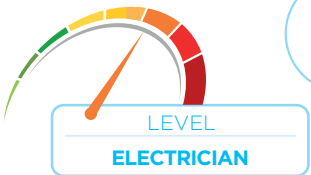

SMART BUILDING

When using wireless elements is faster and cheaper.

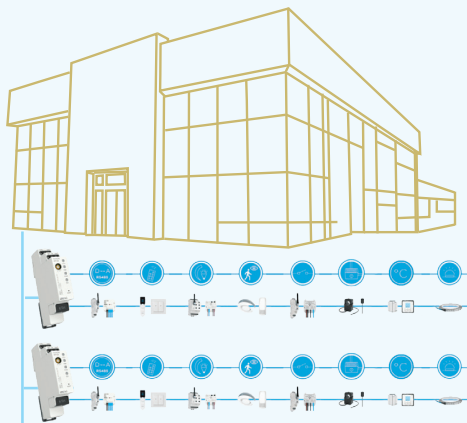
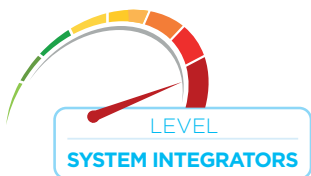

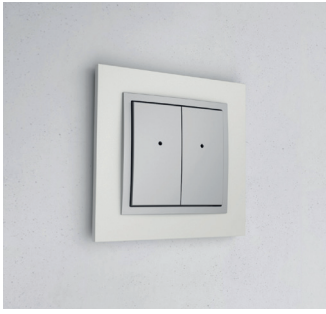

On wall button controllers

RFWB-20 / RFWB-40

- 2 or 4 buttons
- simple installation – can be attached or fixed anywhere
- in LOGUS⁹⁰ design frames (natural materials and colour combinations)

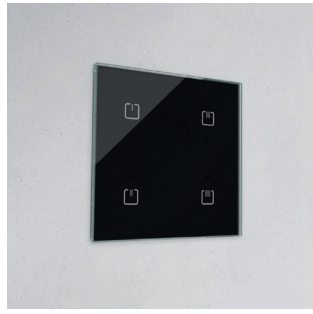

Glass touch controller

RFGB-20 / RFGB-40

- wall controller in elegant glass design
- 2 or 4 buttons
- in black or white glass sharp or rounded edges



Wireless touch unit

RF Touch-2/BE, RF Touch-2/BR

- wireless touch unit for flushed mount
- it will become a central, wireless intuitively controlled home
- coloured 4" TFT display
- eLAN-RF gateway included



RF Key

RF Key-40B/W

- 4 or 6 buttons controller
- pocket controller for every day
- in colour white or black



Matter compatibility



iNELS Wireless: units overview	8
Controllers	
RFWB-20/G, RFWB-20/GB, RFWB-40/G, RFWB-40/GB On-wall button controllers – PAIRING BUTTON	14
RFOB-20 Outdoor controller, 2 buttons – (IP65)	15
RFGB-20/W, RFGB-20/B, RFGB-40/W, RFGB-40/B Glass touch controllers, SHARP – PAIRING BUTTON	16
RFSW-xx Glass touch controller with output relays – NEW!	18
RFDW-71, RFDW-271 Glass touch controller with dimmer – NEW!	20
RFGB-220/W, RFGB-220/B, RFGB-240/W, RFGB-240/B Glass touch controllers, ROUND – PAIRING BUTTON	21
RFMB-22, RFMB-42, RFMB-62 Wireless metal pushbutton controller with switching relays – NEW!	22
RF Pilot/W, RF Pilot/A Remote RF controller with display	24
RF KEY-40/W, RF KEY-40/B, RF KEY-60/W, RF KEY-60/B Key fob – PAIRING BUTTON	26
Switches	
RFS-61B Switch unit, 1-channel – (BOX)	27
RFS-61BPF-SL – NEW! , RFS-61B-SL, RFS-62B-SL, RFS-111B-SL Switch units with the inputs for external buttons – (BOX-SL)	28
RFJA-32B-SL Switch unit for shutters – (BOX-SL)	29
RFS-61MI, RFS-61M Switch unit, 1 channel – (1-MODUL DIN rail)	30
RFS-66MI, RFS-66M Switch unit, 6 channels – (3-MODUL DIN rail)	31
RFUS-61 Switch unit with increased protection – (IP65)	32
RFSC-61N Switch socket-plug – (PLUG)	33
Dimmers	
RFDAC-71B-SL Analog controller, 0(1)-10V – (BOX)	34
RFDEL-71B-SL Universal dimmer, 1-channel – (BOX-SL)	35
RFDALI-32B-SL, RFDALI-04B-SL DALI controller, for 32/4 addresses – (BOX-SL) – NEW!	36
RFDEL-71M Universal dimmer, 1-channel – (3-MODUL DIN rail)	37
RFDEL-76M Universal dimmer, 6-channels – (6-MODUL DIN rail)	39
RFDA-73M/RGB Dimmer for LED (RGB) strips, 3-channels – (3-MODUL DIN rail)	40
RFDSC-71N Dimming socket-plug – (PLUG)	42
Temperature control	
RFTC-3 Glass touch thermostat for fancoils – NEW!	44
RFTC-4 Glass touch wireless thermostat – NEW!	45
RFTC-10/G System temperature controller – (LOGUS ⁹⁰)	46
RFTC-50/G Autonomous temperature controller – (LOGUS ⁹⁰)	47
RFSTI-11B-SL Switch unit with external temperature sensor – (BOX-SL)	48
RFTI-20 Temperature and humidity sensor – (SURFACE)	49
RFATV-2 Wireless thermostatic valve	50
TC, TZ Temperature sensors	51
Converters	
RFIM-40B/BP-SL, RFIM-40B/230-SL Input contacts converter – (BOX-SL) – PAIRING BUTTON	52
RFSG-1M Input contact converter (1-MODUL DIN rail) – PAIRING BUTTON	53
RFTM-1 Pulse converter – (IP65)	54
Detectors	
RFSF-100 Flood detector	55
RFSOU-1 Twilight switch – (IP65)	56
RFWD-100 Window/door detector	57
RFMD-100 Motion detector	58
RFMD-200 Motion detector for ceiling mounting – NEW!	59
RFSLT-S3 Wireless hydrostatic level sensor – (IP65) – NEW!	60

System units

RF Touch-2/BE, RF Touch-2/BR | Wireless touch unit – **NEW!** 62

eLAN-RF-103 | Smart RF gateway **MQTT** 64

RFRP-20N | Repeater to extend the range – (PLUG) 65

MATTER

RFWB-40G/MT | On-wall button controllers, 4 buttons **MATTER** – (LOGUS⁹⁰) 66

RFGB-40B/MT, RFGB-40W/MT | Glass touch controller – 4 buttons, SHARP **MATTER** 67

RFSAI-62B-SL/MT | Switch unit with inputs for external buttons **MATTER** – (BOX-SL) 68

RFDEL-71B-SL/MT | Universal dimmer **MATTER** 69

RFMD-200/MT | Motion detector for ceiling mounting **MATTER** 70

RFWD-100/MT | Window/door detector **MATTER** – **NEW!** 71

HRESK

RFGS-30/S | Infront of door hotel room unit – **NEW!** 74

RFSW-xx/S | Glass touch wireless controller with symbols – **NEW!** 76

RFS-266M | Switch unit for fancoil control – **NEW!** 78

RFSTI-111B | Overheating/overcooling switch unit with advanced functions – (BOX) 79

Accessories

AN-I | Internal antenna 81

RFAF/USB | Service Key 81

AN-E1 | External antenna 82

AN-E3 | External antenna 82

MS | Sensors for RFTM-1 83

WS | Sensors for RFTM-1 83

LS | Sensors for RFTM-1 83

Overview of functions

Applications 84

Voice assistants 86

Protocol and compatibility 87

Product loadability 88

Pairing controllers with iNELS Wireless devices 90

Setting the functions on the controllers 92

Installation possibilities 93

Product dimension 94

Scope Architecture 96

Controllers



P

RFWB-20/G – white
RFWB-20/GB – black
 On-wall button controller
 - 2 buttons



P

RFWB-40/G – white
RFWB-40/GB – black
 On-wall button controller
 - 4 buttons



IP 65

RFOWB-20
 Outdoor controller
 - 2 buttons



P

RF KEY-40/W – white
RF KEY-40/B – black
 Key fob – 4 buttons



P

RF KEY-60/W – white
RF KEY-60/B – black
 Key fob – 6 buttons



RF Pilot/W – white
RF Pilot/A – anthracite
 Remote Wireless controller
 with display



P

RFGB-20/W – white
RFGB-20/B – black
 Glass touch controller
 SHARP – 2 buttons



P

RFGB-40/W – white
RFGB-40/B – black
 Glass touch controller
 SHARP – 4 buttons



P

RFGB-220/W – white
RFGB-220/B – black
 Glass touch controller,
 ROUND – 2 buttons



P

RFGB-240/W – white
RFGB-240/B – black
 Glass touch controller,
 ROUND – 4 buttons



N

RFSW-42/B – black glass, SHARP
RFSW-242/W – white glass, ROUND
 Glass touch controller
 with output relays



N

RFDW-71/B – black glass, SHARP
RFDW-271/W – white glass, ROUND
 Glass touch controller
 with dimmer

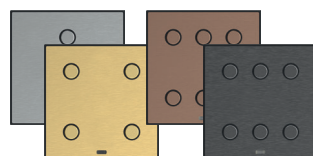

N

RFMB-22 – two buttons
RFMB-42 – four buttons
RFMB-62 – six buttons
 Wireless metal pushbutton controller with
 switching relays

Legend:

N

NEW

P

PAIRING
BUTTON

IP 65

INCREASED
PROTECTION

MATTER



MQTT

Switch units



RFS-61B

Switch unit, 1 channel
– 1x 16 A, multifunction



RFSAI-61BPF-SL

Switch unit with inputs for
external buttons – 1x 8 A,
multifunction, galvanically
separated



RFSAI-11B-SL

Switch unit with inputs for
external buttons – 1x 8 A,
singlefunction



RFSAI-61B-SL

Switch unit with inputs for
external buttons – 1x 8A,
multifunction



RFSAI-62B-SL

Switch unit with inputs for
external buttons 2-channels,
2x 8 A (total), multifunction

N



RFJA-32B-SL

Switch unit for shutters,
2x 8 A



RFS-66MI

Switch unit, 6 channels with
integrated antenna
– multifunction, 6x 8 A



RFS-61MI

Switch unit, 1 channel with
integrated antenna
– multifunction, 1x 16 A



RFS-66M

Switch units, 6 channels
– multifunction, 6x 8 A



RFS-61M

Switch unit, 1 channel – multi-
function, 1x 16 A



**IP
65**

RFUS-61

Switch unit with increased
protection, 1x 12 A,
multifunction



RFSC-61N

Switching socket-plug,
– 1x 16 A, multifunction

Dimmers



RFDAC-71B-SL

Analog controller,
0(1)-10 V



**RFDALI-32B-SL
RFDALI-04B-SL**

DALI controller,
for 4/32 DALI addresses



RFDEL-71B-SL

Universal dimmer
1-channel – 1x 300 VA
– R, L, C, LED, ESL



RFDEL-71M

Universal dimmer,
1-channel – 1x 600 VA
– R, L, C, LED, ESL



RFDEL-76M

Universal dimmer,
6-channels – 6 x 150 VA



RFDA-73M/RGBW

Dimmer for LED (RGB) strips,
3-channels



RFDSC-71N

Dimming socket-plug

Temperature control



N

RFTC-3

Glass touch thermostat for fancoils



N

RFTC-4

Glass touch wireless thermostat

**RFTC-10/G**

System temperature controller

**RFTC-50/G**

Autonomous temperature controller

**RFSTI-11B-SL**

Switch unit with external temperature sensor

**TC TZ**

Temperature sensors

**RFATV-2**

Wireless thermovalve



N

RFTI-20

Temperature and humidity sensor

Converters



P

RFIM-40B/BP-SL

4 input contacts converter battery powered



P

RFIM-40B/230V-SL

4 input contacts converter AC 230 power supply



P

RFSG-1M

Input contact converter -1x permanent contact

**RFTM-1**

Puls converter

Detectors

**RFSF-100**

Flood detector



IP 65

RFSOU-1

Twilight switch

**RFWD-100**

Window/Door detector

**RFMD-100**

Motion detector

**RFSLT-S3**

Wireless hydrostatic level sensor



N

RFMD-200

Motion detector

System units



eLAN-RF-103
Smart RF gateway
with LAN



RFRP-20N
Repeater to extend
the range



RF Touch-2/BE
RF Touch-2/BR
Wireless touch unit
– flush mounted

Matter

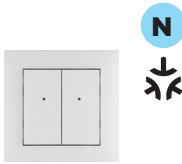

RFBW-40G/MT
On-wall button controller
– 4 buttons

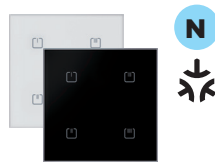

RFGB-40B/MT – black glass
RFSW-40W/MT – white glass
Glass touch controller - 4 buttons,
SHARP / MATTER

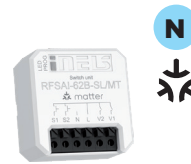

RFSAI-62B-SL/MT
Switch unit with inputs for
external buttons MATTER,
2x 8 A (total)

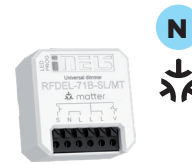

RFDEL-71B-SL/MT
Universal dimmer, 1-channel
– 1x 300 VA, MATTER

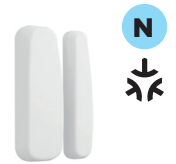

RFWD-100/MT
Window/Door
detector MATTER



RFMD-200/MT
Motion detector MATTER

Hotel Retrofit (HRESK)

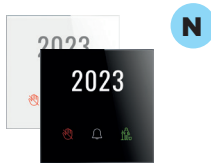

RFGS-30/SB – black glass
RFGS-30/SW – white glass
Infront of door hotel
room unit



RFSW-62/SB – black glass
RFSW-62/SW – white glass
Wireless touch glass remote
control with symbols



RFS-266M
Switch unit for
fancoil control



RFSAI-161B
Lighting control unit
with pair detectors and
external button input



RFSTI-111B
Overheating/overcooling
switch unit with advanced
functions

Accessories



RFAF/USB
Service Key



AN-I
Internal antenna
Gain: 2.1 dBi





AN-E
External antenna
Gain: 5 dBi



AN-E3
External antenna
Gain: 3 dBi, IP67



Extension cable for external
antenna
10 m

-  **RFIO/RFI02** - radiofrequency protocol bidirectional
-  **Wi-Fi**
-  **LAN**

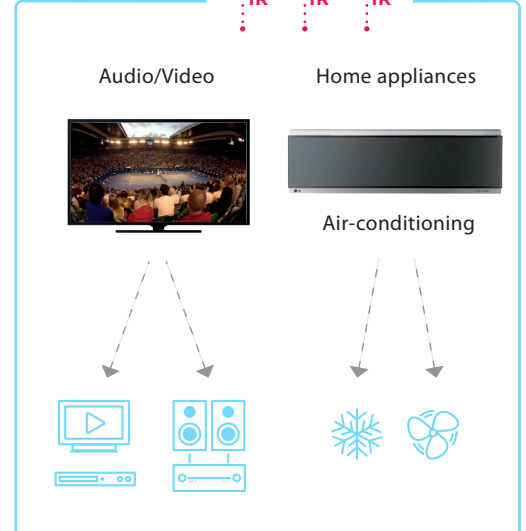
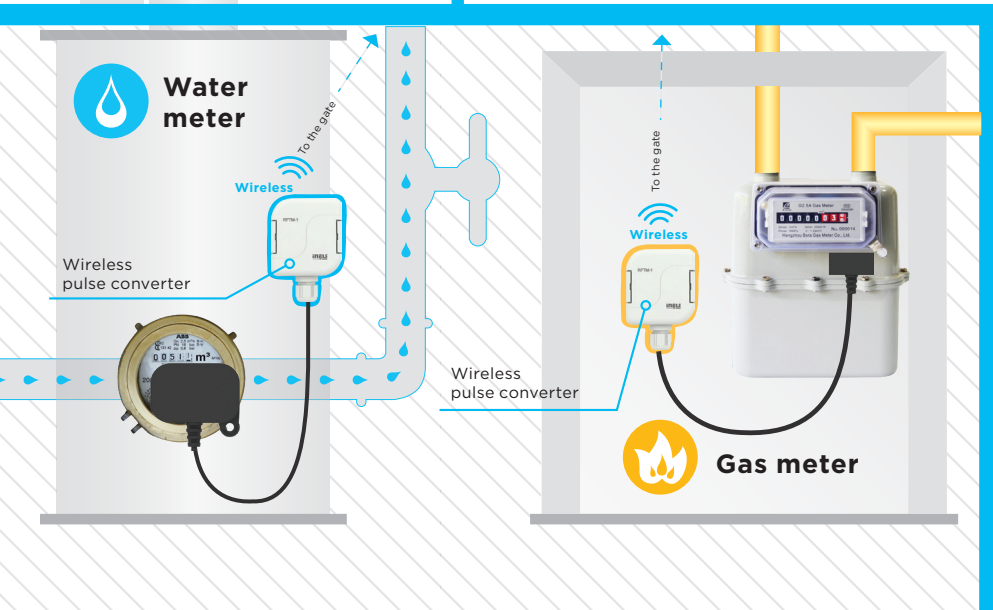
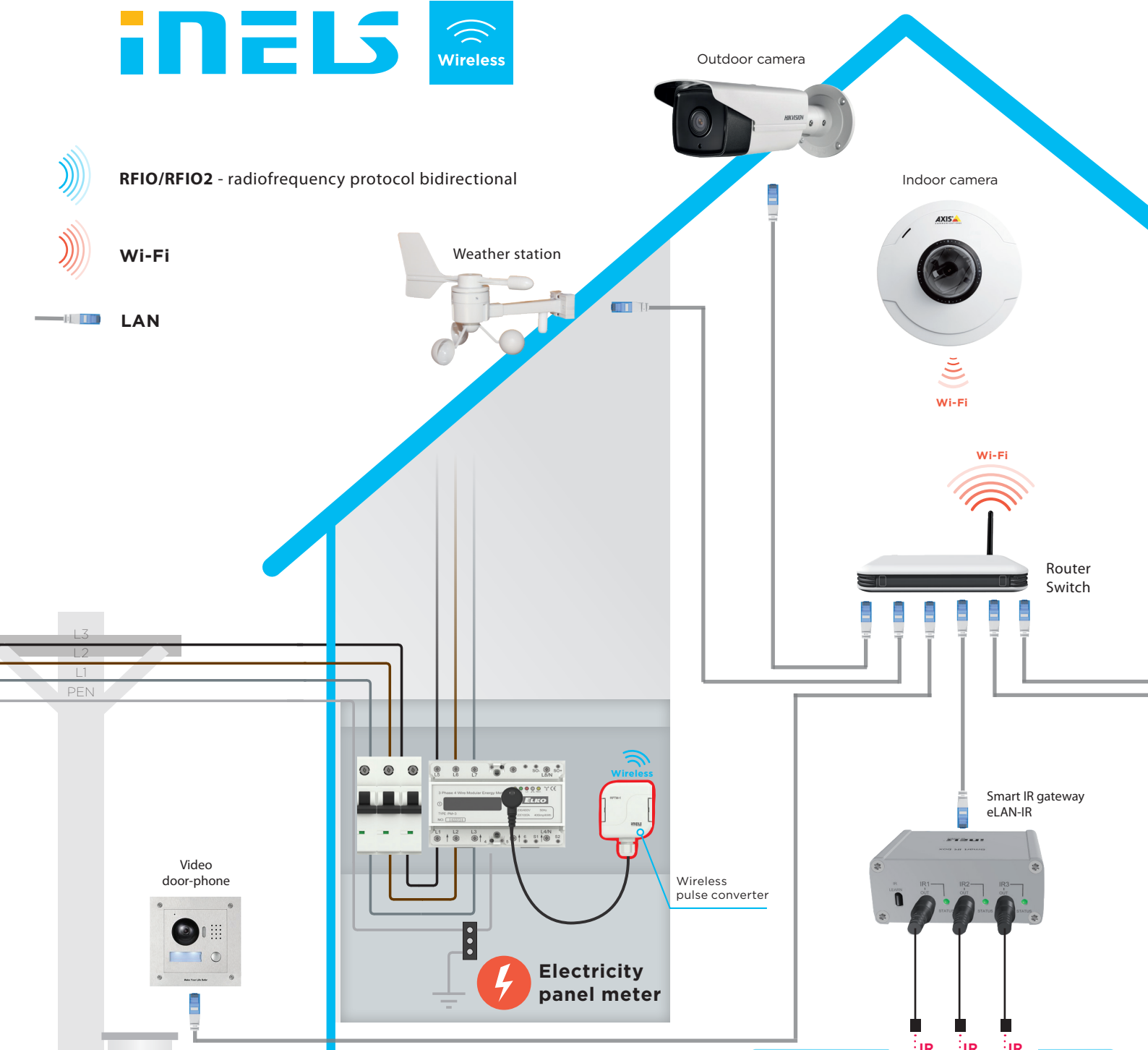

SW/APP

iNELS Cloud API
SAMSUNG Smart TV
 amazon alexa Google Home
 App iNELS.cloud Smart TV application Voice assistants Smart watch

Controllers:

Radio & Intercom Touch unit Wall controller Glass controller Thermostat Glass Touch controller with dimmer RF Pilot / Key fob

Smart RF gateway eLAN-RF-103
MQTT

Detectors:

RFSLT-S3 Door/window Motion Flood

Sensors:

Temperature Twilight

Units:

Switch unit - 6 outputs Switch unit to installation box Switching socket Switch unit for shutters Switch unit - 1-channel Dimmer for LED strips



EAN code:

RFWB-20/G: 8595188140379

RFWB-20/GB: 8595188191616

RFWB-40/G: 8595188140607

RFWB-40/GB: 8595188191623

Technical parameters RFWB-20/G(GB) RFWB-40/G(GB)

Supply voltage:	3 V CR 2032 battery	
Battery life:	around 5 years based on frequency of use	
Transmission indication:	red LED	
Number of buttons:	2	4
Communication protocol:	RFIO	
Frequency:	866–922 MHz (for more information see p. 85)	
Signal transmission method:	unidirectionally addressed message	
Range:	in open space up to 200 m	

Other data

Operating temperature:	-10 to +50 °C	
Operating position:	any	
Mounting:	glue/screws	
Protection:	IP20	
Contamination degree:	2	
Dimensions frame		
- plastic:	85 x 85 x 16 mm	
- metal, glass, wood, granite:	94 x 94 x 16 mm	
Weight (plastic):*	38 g	39 g
Related standards:	EN 60730, EN 63044, EN 300 220, EN 301 489	

- On-wall button controller is used to control switches and dimmers (lights, gate, garage door, blinds, etc.).
- RFWB-20/G(GB): two buttons enable control of two units independently.
- RFWB-40/G(GB): four buttons enable control of four units independently.
- The flat design with level base makes it ideal for fast installation on any surface (fixation with adhesive or screws in the installation box).
- When pressing the button, it sends a set signal (ON/OFF, dimming, time switching OFF/ON, blinds up/down).
- Sending a command is indicated by a red LED.
- In LOGUS⁹⁰ switch frame design (plastic, glass, wood, metal, stone).
- Option of setting light scenes, where with a single press, you can control units of iNELS Wireless.
- Battery power supply (3 V CR 2032 battery - included in the supply) with battery life of around 5 years based on frequency of use.
- Range up to 200 m (in open space), if the signal is insufficient between the controller and unit, use the signal repeater RFRP-20N or protocol component RFIO2 that support this feature.
- RFWB enables communication (RFIO2) and can thus communicate with the CU3-02M.
- Attention: The controller is paired with the elements using the pairing button. Ord. codes for controllers with pairing button: RFWB-20/G Order No.: 8502, RFWB-40/G Order No.: 8489, see Pairing controllers on p. 88.

Device description

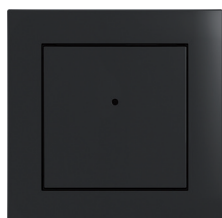
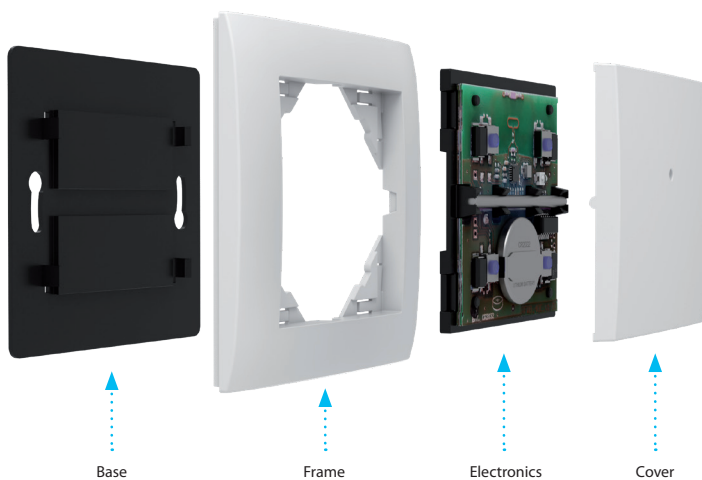
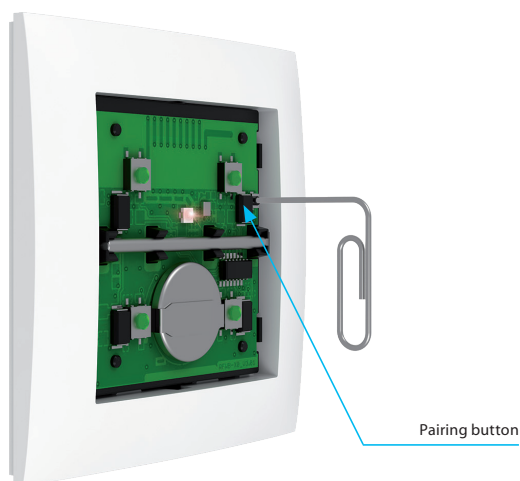
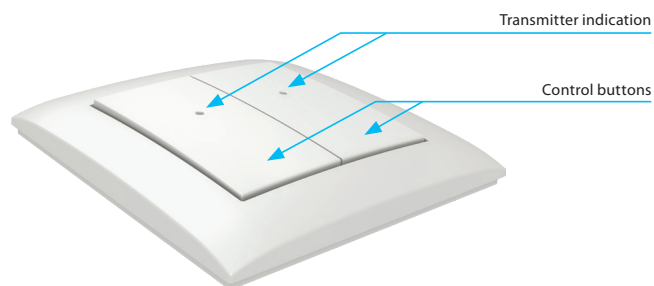

RFWB-20/GB

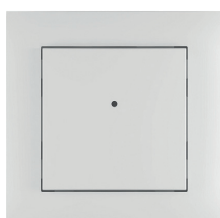

RFWB-20/G



RFWB-40/GB

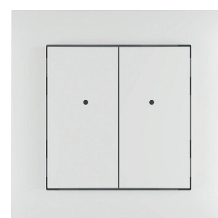

RFWB-40/G



- The wireless push-button controller with IP65 protection is used to control iNELS Wireless components and protect them from the outdoor environment.
- 2 buttons allow (independently of each other) control of an unlimited number of components (actuators).
- The controller is suitable for control from the pool, garden, terrace, and pergola. It can be used as an uncovered bell button.
- Fastening with screws or double-sided tape.
- Battery power supply (3 V CR 2032 battery - included in the supply) with battery life of around 5 years based on frequency of use.
- Pairing controllers on p. 88

EAN code:
RFOWB-20: 8595188181471

Technical parameters		RFOWB-20
Supply voltage:	3 V CR 2032 battery	
Battery life:	around 5 years based on frequency of use	
Transmission indication:	Integrated red LED	
Number of buttons:	2	
Communication protocol:	RFIO	
Frequency:	866–922 MHz (for more information see p. 85)	
Signal transmission method:	unidirectionally addressed message	
Range:	in open space up to 200 m	
Other data		
Operating temperature:	-10 to +50 °C	
Mounting:	screws/double sided tape	
Colour design:	white (RAL 9003)	
Protection:	IP65	
Contamination degree:	2	
Dimensions frame:	64 x 74 x 44 mm	
Weight:	112 g	
Related standards:	EN 60730, EN 63044, EN 300 220, EN 301 489	

Device description

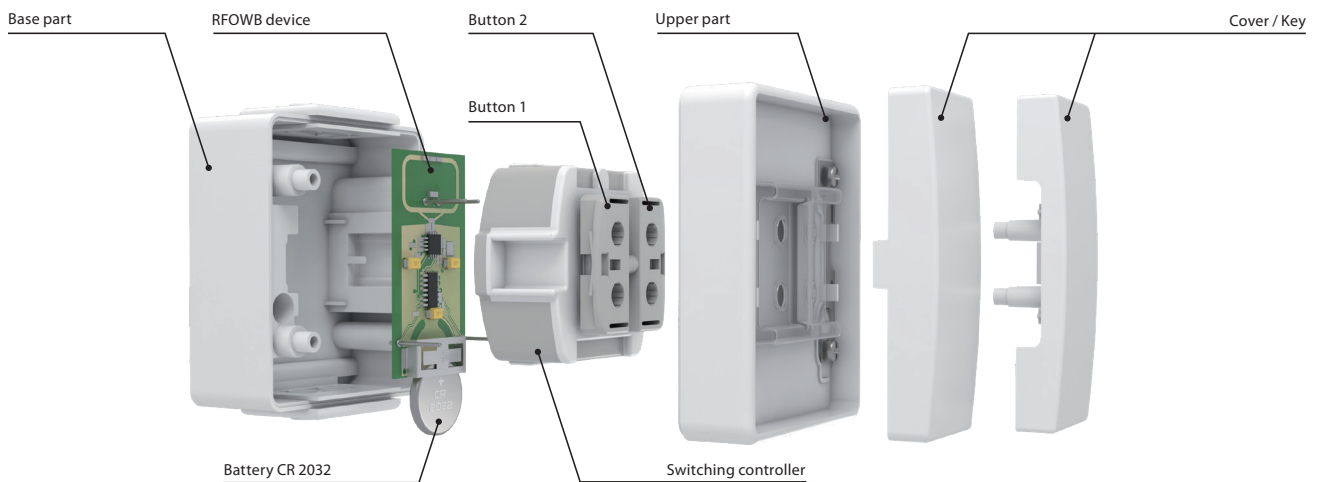
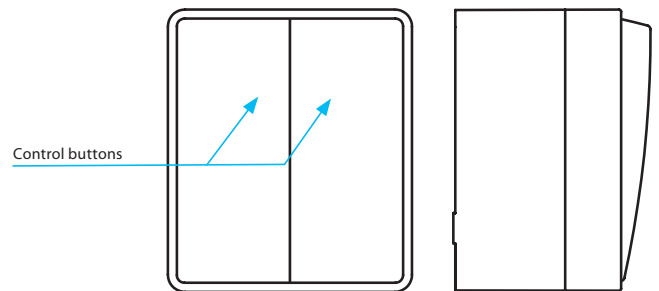

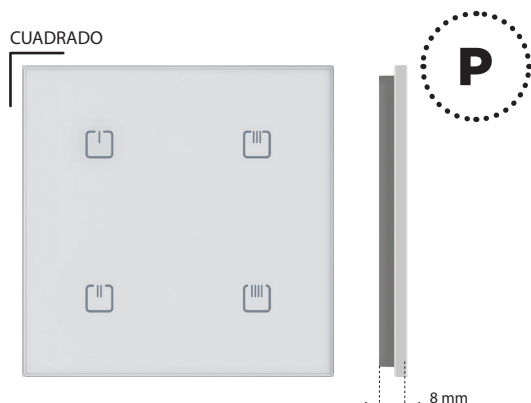

RFGB-20/W: 8595188176781 RFGB-40/W: 8595188176804
 RFGB-20/B: 8595188176798 RFGB-40/B: 8595188176811

Technical parameters	RFGB-20	RFGB-40
Supply voltage:	2x 3 V CR 2032 batteries	
Battery life:	around 2 years based on frequency of use	
Transmission indication:	red LED	
Number of capacitive buttons:	2	4
Communication protocol:	RFIO	
Frequency:	866–922 MHz (for more information see p. 85)	
Signal transmission method:	unidirectionally addressed message	
Range:	in open space up to 200 m	
Other data		
Operating temperature:	-10 to +50 °C	
Operating position:	any	
Mounting:	glue/screws	
Protection:	IP20	
Contamination degree:	2	
Dimensions:	94 x 94 x 8 mm	
Weight:	107 g	107 g
Related standards:	EN 60730, EN 63044, EN 300 220, EN 301 489	

- The glass touch controller is a design iNELS Wireless unit and is available in elegant black and white variants.
- Only 8 mm thick.
- **RFGB-20:** 2 capacitive buttons allows to control 2 devices.
- **RFGB-40:** 4 capacitive buttons allows to control 4 devices.
- When pressing the button, it sends a set signal (ON/OFF, dimming, time switching OFF/ON, blinds up/down). Sending a command is indicated by a red LED.
- Option of setting light scenes, where with a single press, you can control units of iNELS Wireless.
- The rear base allows to be attached to installation using screws, double-sided tape or keeping controller on the table.
- Battery power supply (2x 3 V CR 2032 batteries - included in the supply) with battery life of around 2 years based on frequency of use.
- Range up to 200 m (in open space), if the signal is insufficient between the controller and unit, use the signal repeater RFRP-20N or protocol component RFIO2 that support this feature.
- Attention: The controller is paired with the elements using the pairing button. Ord. codes for controllers with pairing button: RFGB-20/W Order No.: 8513, RFGB-20/B Order No.: 8512, RFGB-40/W Order No.: 8514, RFGB-40/B Order No.: 8488, see Pairing controllers on p. 88.

Device description

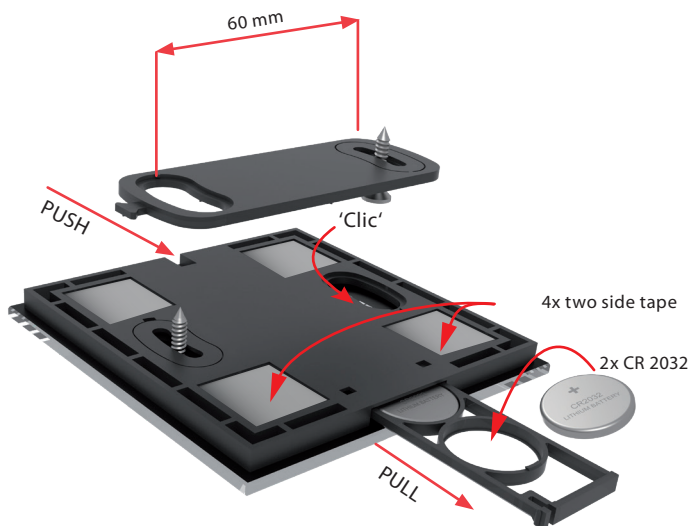
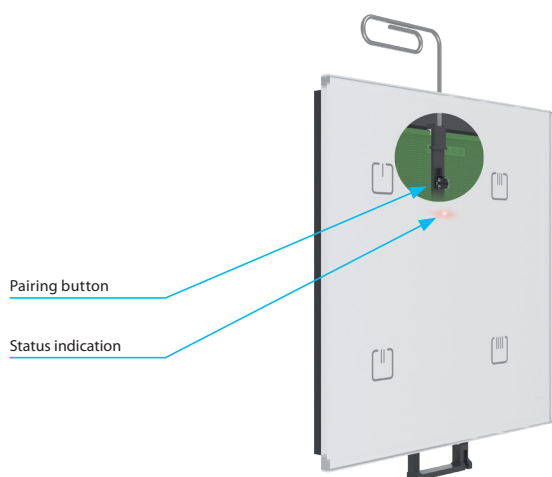
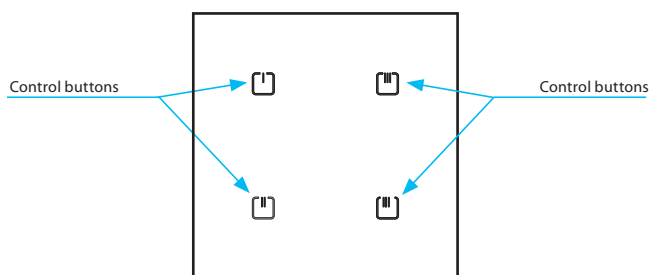

Variants



RFGB-20/W

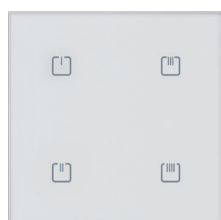

RFGB-40/W



RFGB-20/B

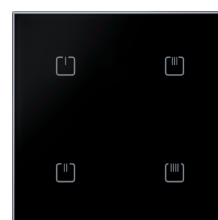

RFGB-40/B

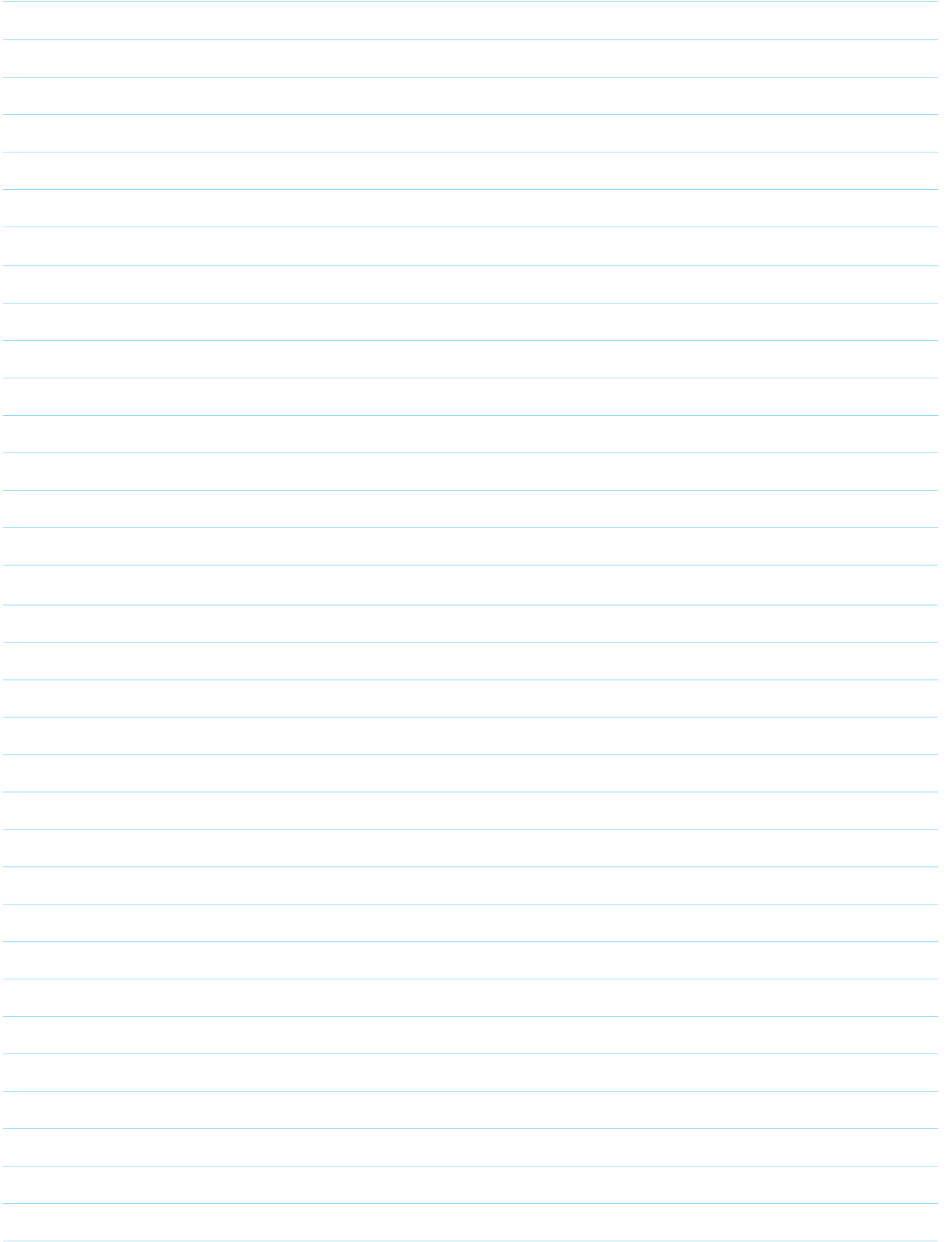

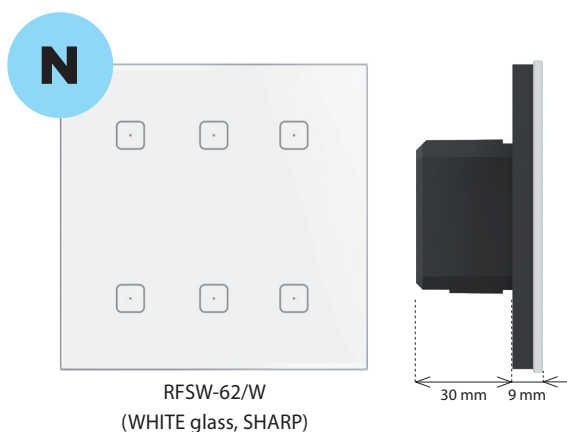

Technical parameters

RFSW-xx

Supply voltage:	230 V AC / 50-60 Hz	24 V AC/DC
Apparent / Dissipated power:	1.2 VA/0.6 W	0.6 VA/0.6 W
Supply voltage tolerance:	±10 %	

Output

Relays capacity:	2x switching / 8 A / AC1 / 2000 VA / ZERO CROSS
Peak current:	$I_{peak} < 110A$ 300us / max. input capacitance 125 uF
Mechanical life:	mechanical 10 mil. / electrical 100,000 cycles

Control

Control items:	4 or 6 buttons
Communication:	wireless, iNELS RFIO2 protocol
Frequency:	866-922 MHz (more on page 85)
Repeater Function:	yes
Range:	in open areas up to 160 m

Connection

Terminal block:	screwless - push in
Wire gauge:	0.2 - 1.5 mm ² solid flexible

Other data

Operating temperature:	-10 to +50 °C
Storing temperature:	-30 to +70 °C
Protection degree:	front IP60 / rear IP20
Overvoltage category:	II.
Pollution degree:	2
Operation position:	any
Installation:	flush mount to the installation box, BS or EU standard
Dimensions:	Sharp: 94 x 94 x 39 mm / Round: 100 x 100 x 39 mm
Weight:	Sharp: 131 g / Round: 138 g
Related standards:	EN 60730, EN 63044, EN 301489, EN 300 220

- The glass design controller with two output relays is used to control appliances and lights.
- The 4 or 6 button touch controls on the circuit breaker allow you to directly control the output relay as well as other components of the installation.
- The backlight intensity (white LED) of the buttons is automatically adjusted depending on the ambient lighting.
- They can be combined with detectors, controllers, iNELS Wireless or system components.
- 6 functions – button, impulse relay and time function of delayed start or return with a time setting of 2 s - 60 min. Any function can be assigned to each output relay. Function description can be found on p. 90.
- Possibility to set the memory of the output state during a power failure and subsequent restoration of the power supply.
- Each of the outputs can be controlled by up to 12/12 channels (1 channel represents one button on the controller).
- Range up to 160 m (in open space).
- Communication frequency with bidirectional protocol RFIO2.
- Pairing controllers on p. 88.
- Available with AC 230V or AC/DC 24V power supply with the option of galvanically isolated relay output contacts from the power supply (see table on the next page and connection below)

Instrument description

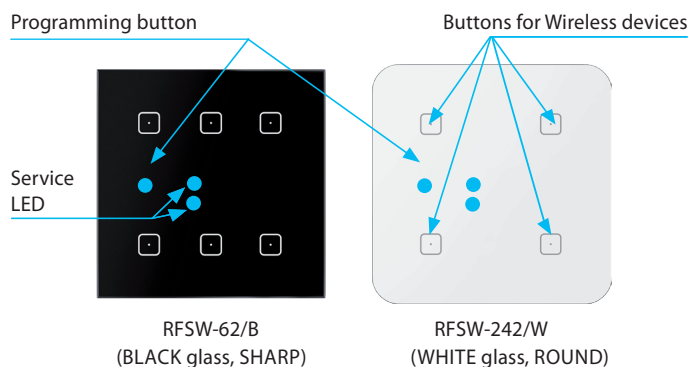

The output can be controlled by up to 25 separate buttons (external Wireless Controller).

The buttons can control an unlimited number of Wireless devices.

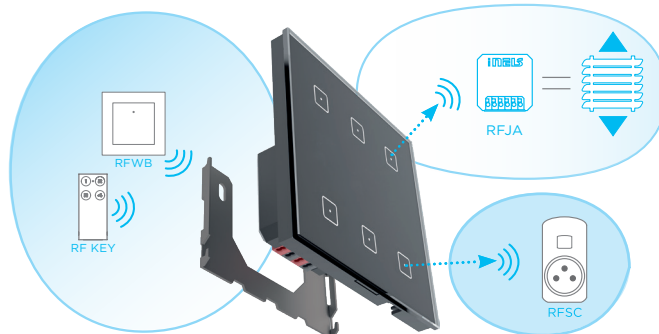

Output relays are equipped with ZERO CROSS technology, which allows switching the load when the voltage passes zero, i.e. in the minimum current consumption, which prevents burning and sticking of relay contacts - especially when switching electronic ballasts, which are part of each LED luminaire.

Connection

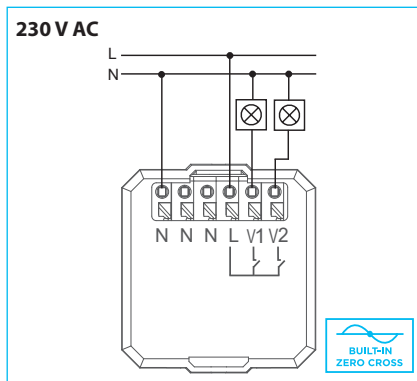

The output contacts (V1, V2) switch the phase potential (L) and are equipped with **zero cross** switching technology

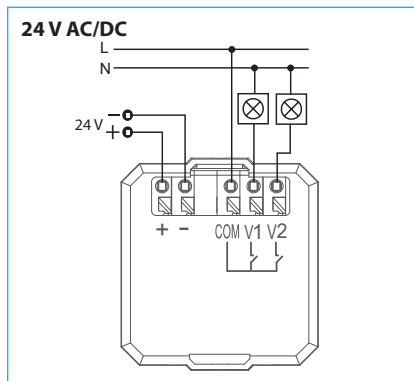

The output contacts (V1, V2) are galvanically isolated from the power supply and share a common COM terminal

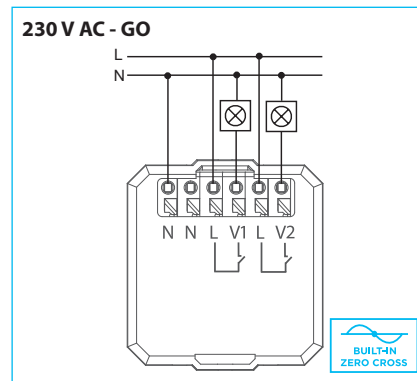

Output contact V1 is at the same potential as the product power supply. Output contact V2 is separate from the power supply but must be connected to the same potential. The wiring is used when it is necessary to secure V1 and V2 separately.

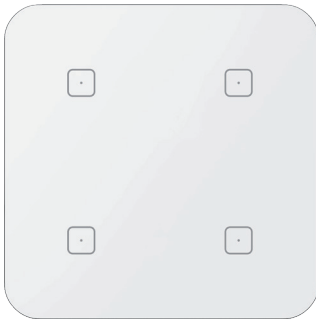

RFSW-242/W



RFSW-262/W

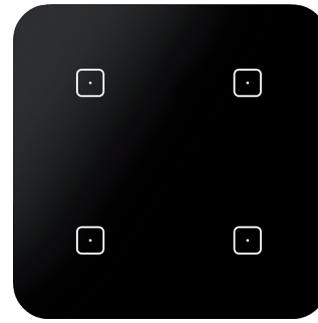

RFSW-242/B

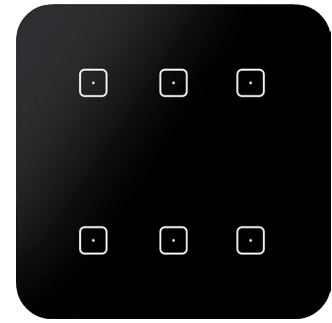

RFSW-262/B

(WHITE glass, ROUND)

(BLACK glass, ROUND)



RFSW-42/W

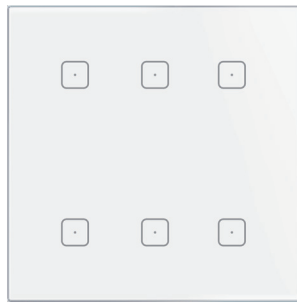

RFSW-62/W

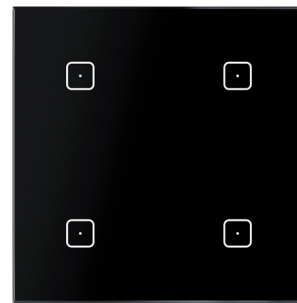

RFSW-42/B

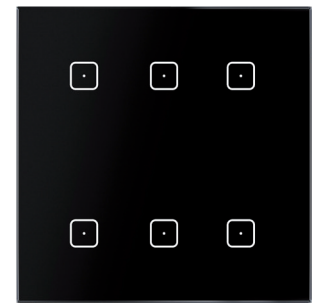

RFSW-62/B

(WHITE glass, SHARP)

(BLACK glass, SHARP)

Icons are illustrative - configure your own look using the configurator: icons.inels.com



Type	Number of buttons	Design ROUND SHARP	Glass colour	Power supply	Galvanically isolated output contact	EAN	Code
RFSW-42/W/230V	4	S	White	AC 230 V	–	8595188193825	9382
RFSW-62/W/230V	6	S	White	AC 230 V	–	8595188194525	9452
RFSW-242/W/230V	4	R	White	AC 230 V	–	8595188193849	9384
RFSW-262/W/230V	6	R	White	AC 230 V	–	8595188194532	9453
RFSW-42/B/230V	4	S	Black	AC 230 V	–	8595188193818	9381
RFSW-62/B/230V	6	S	Black	AC 230 V	–	8595188194501	9450
RFSW-242/B/230V	4	R	Black	AC 230 V	–	8595188193832	9383
RFSW-262/B/230V	6	R	Black	AC 230 V	–	8595188194518	9451
RFSW-42/W/24V	4	S	White	AC/DC 24 V	✓	8595188194488	9448
RFSW-62/W/24V	6	S	White	AC/DC 24 V	✓	8595188194587	9458
RFSW-242/W/24V	4	R	White	AC/DC 24 V	✓	8595188194495	9449
RFSW-262/W/24V	6	R	White	AC/DC 24 V	✓	8595188194617	9461
RFSW-42/B/24V	4	S	Black	AC/DC 24 V	✓	8595188194464	9446
RFSW-62/B/24V	6	S	Black	AC/DC 24 V	✓	8595188194587	9458
RFSW-242/B/24V	4	R	Black	AC/DC 24 V	✓	8595188194471	9447
RFSW-262/B/24V	6	R	Black	AC/DC 24 V	✓	8595188194594	9459
RFSW-42/WGO/230V	4	S	White	AC 230 V	✓	8595188194440	9444
RFSW-62/WGO/230V	6	S	White	AC 230 V	✓	8595188194563	9456
RFSW-242/WGO/230V	4	R	White	AC 230 V	✓	8595188194457	9445
RFSW-262/WGO/230V	6	R	White	AC 230 V	✓	8595188194570	9457
RFSW-42/BGO/230V	4	S	Black	AC 230 V	✓	8595188194426	9442
RFSW-62/BGO/230V	6	S	Black	AC 230 V	✓	8595188194549	9454
RFSW-242/BGO/230V	4	R	Black	AC 230 V	✓	8595188194433	9443
RFSW-262/BGO/230V	6	R	Black	AC 230 V	✓	8595188194556	9455

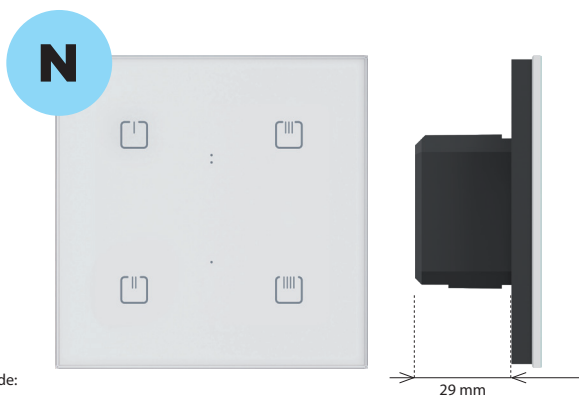

EAN code:

RFDW-71/W: 8595188188944

RFDW-271/W: 8595188188951

RFDW-71/B: 8595188188241

RFDW-271/B: 8595188188937

Technical parameters RFDW-71/230V, RFDW-271/230V

Supply voltage:	230 V AC / 50-60 Hz
Apparent power:	1.1 VA
Dissipated power:	0.8 W
Supply voltage tolerance:	±10 %
Dimmed load:	R,L,C, LED, ESL

Output

Contactless:	2 x MOSFET
Load capacity:*	max. 160 W

Control

Wireless:	up to 25-channels (buttons)
Communication protocol:	RFIO2
Frequency:	866-922 MHz (for more information see p. 85)
Repeater function:	yes
Manual control:	4 touch keys, button PROG
Button backlight:	white LED with intensity change
Indications PROG:	red/green LED
Range:	in open space up to 160 m

Connection

Max. cable size (mm ²):	screwless clamps 0.2 - 1.5 mm ² solid/flexible
-------------------------------------	--

Other data

Operating temperature:	-10 to +40 °C
Storing temperature:	-30 to +70 °C
Protection degree:	IP20
Overvoltage category:	II.
Pollution degree:	2
Operation position:	any
Installation:	into installation box
Dimensions:	94 x 94 x 41 mm
Weight:	129 g
Related standards:	EN 60730, EN 63044, EN 301489, EN 300 220

* See page 75 for the load chart for each light source.

The glass design controller with dimmer and touch buttons is used to control light sources:

R – classic lamps (resistive load)

L – halogen lamps with wound transformer (inductive load)

C – halogen lamps with electronic transformer (capacity load)

ESL – dimmable energy-efficient fluorescent lamps

LED – LED light sources (230 V) equipped with LED.

- The touch buttons on the circuit breaker allow you to directly control the integrated dimmer as well as other components of the installation.
- The backlight intensity (white LED) of the buttons is automatically adjusted depending on the ambient lighting.
- They can be combined with detectors, controllers, iNELS Wireless or system components for output control from other locations.
- 7 light functions – smooth increase or decrease with time setting 2 s – 30 min. Function description can be found on p. 82.
- When switched off, the set level is stored in the memory, and when switched back on, it returns to the most recently set value.
- Thanks to setting the min. brightness you will eliminate flashing of the LED and ESL light sources.
- The universal dimmer may be controlled by up to 25-channels.
- Possibility to set the memory status in case of power failure.
- Range up to 160 m (in open space), if the signal is insufficient between the controller and unit, use the signal repeater RFRP-20N or protocol component RFIO2 that support this feature.
- Communication frequency with bidirectional protocol RFIO2.
- Pairing controllers on p. 88.

Colour variants

Programming button

4x control buttons

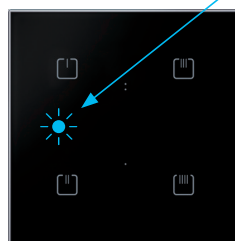

RFDW-71/B
(Black glass, sharp edges)

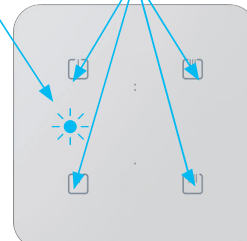

RFDW-271/W
(White glass, round edges)

Connection

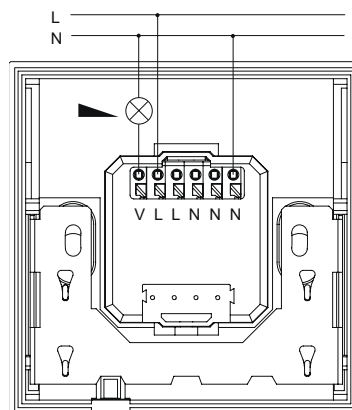

The output can be controlled by up to 25 separate buttons (external Wireless Controller).



The buttons can control an unlimited number of Wireless devices.



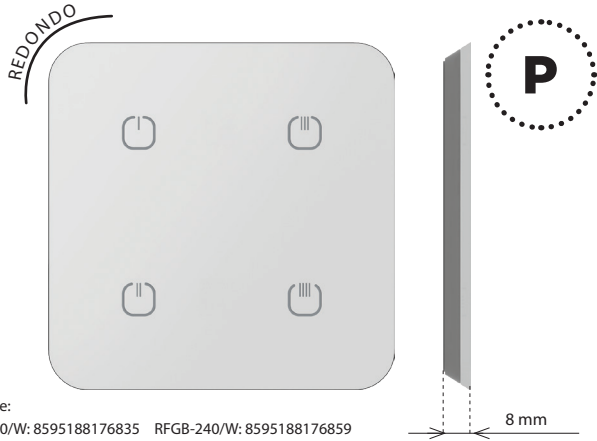

EAN code:
 RFGB-220/W: 8595188176835 RFGB-240/W: 8595188176859
 RFGB-220/B: 8595188176842 RFGB-240/B: 8595188176866

Technical parameters	RFGB-220	RFGB-240
Supply voltage:	2x 3 V CR 2032 batteries	
Battery life:	around 2 years based on frequency of use	
Transmission indication:	red LED	
Number of capacitive buttons:	2	4
Communication protocol:	RFIO	
Frequency:	866–922 MHz (for more information see p. 85)	
Signal transmission method:	unidirectionally addressed message	
Range:	in open space up to 200 m	
Other data		
Operating temperature:	-10 to +50 °C	
Operating position:	any	
Mounting:	glue/screws	
Protection:	IP20	
Contamination degree:	2	
Dimensions:	100 x 100 x 8 mm	
Weight:	108 g	108 g
Related standards:	EN 60730, EN 63044, EN 300 220, EN 301 489	

- The glass touch controller is a design iNELS Wireless unit and is available in elegant black and white variants.
- Only 8 mm thick.
- **RFGB-220:** 2 capacitive buttons allows to control 2 devices.
- **RFGB-240:** 4 capacitive buttons allows to control 4 devices.
- When pressing the button, it sends a set signal (ON/OFF, dimming, time switching OFF/ON, blinds up/down). Sending a command is indicated by a red LED.
- Option of setting light scenes, where with a single press, you can control units of iNELS Wireless.
- The rear base allows to be attached to installation using screws, double-sided tape or keeping controller on the table.
- Battery power supply (2x 3 V CR 2032 batteries - included in the supply) with battery life of around 2 years based on frequency of use.
- Range up to 200 m (in open space), if the signal is insufficient between the controller and unit, use the signal repeater RFRP-20N or protocol component RFIO2 that support this feature.
- Attention: The controller is paired with the elements using the pairing button. Ord. codes for controllers with pairing button: RFGB-220/W Order No.: 8517, RFGB-220/B Order No.: 8518, RFGB-240/W Order No.: 8515, RFGB-240/B Order No.: 8516, see Pairing controllers on p. 88.

Device description

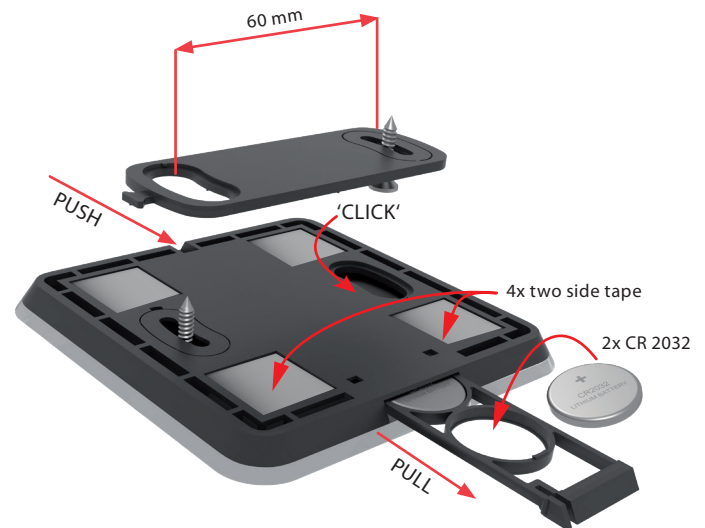
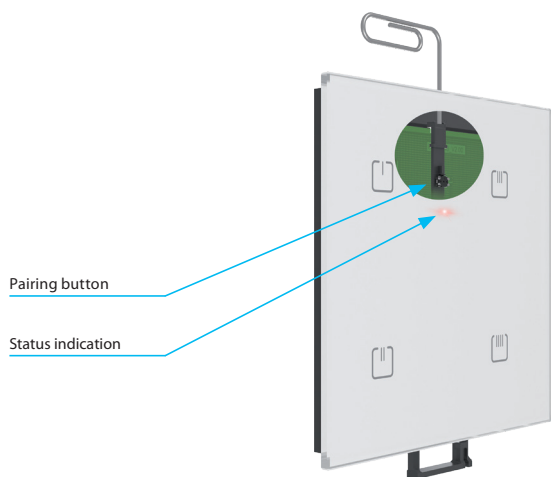
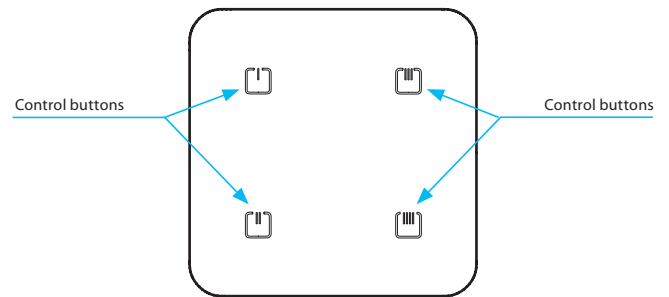

Variants



RFGB-220/W



RFGB-240/W



RFGB-220/B



RFGB-240/B

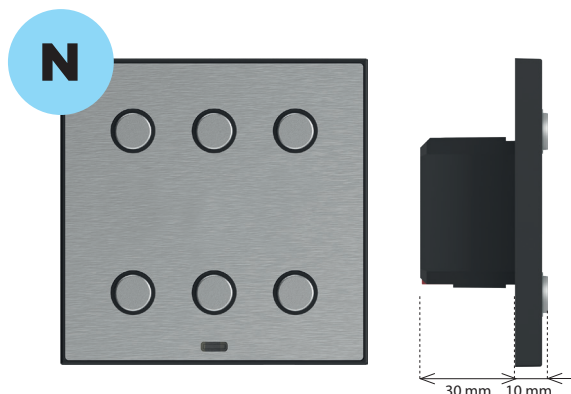

Technical parameters	RFMB-xx
Supply voltage:	110 - 230 V AC / 50-60 Hz
Apparent / Dissipated power:	1.2 VA/0.6 W
Supply voltage tolerance:	±10 %
Output	
Relays capacity:	2x switching / 8 A / AC1 / 2000 VA / ZERO CROSS
Peak current:	$I_{peak} < 110A$ 300us / max. input capacitance 125 uF
Mechanical life:	mechanical 10 mil. / electrical 100,000 cycles
Control	
Control items:	2, 4 or 6 buttons
Communication:	wireless, iNELS RFIO2 protocol
Frequency:	866-922 MHz (more on page 85)
Repeater Function:	yes
Range:	in open areas up to 160 m
Connection	
Terminal block:	screwless - push in
Wire gauge:	0.2 - 1.5 mm ² solid/flexible
Other data	
Operating temperature:	-10 to +50 °C
Storing temperature:	-30 to +70 °C
Protection degree:	front IP60 / rear IP20
Overvoltage category:	II.
Pollution degree:	2
Operation position:	any
Installation:	flush mount to the installation box, BS or EU standard
Dimensions:	Sharp: 94 x 94 x 40 mm
Weight:	160 g
Related standards:	EN 60730, EN 63044, EN 301489, EN 300 220

- The design controller with two output relays.
- The 4 or 6 button touch controls on the circuit breaker allow you to directly control the output relay as well as other components of the installation.
- The backlight intensity (white LED) of the buttons is automatically adjusted depending on the ambient lighting.
- They can be combined with detectors, controllers, iNELS Wireless or system components.
- Possibility to set the memory of the output state during a power failure and subsequent restoration of the power supply.
- Each of the outputs can be controlled by up to 12/12 channels (1 channel represents one button on the controller).
- Range up to 160 m (in open space).
- Communication frequency with bidirectional protocol RFIO2.
- Pairing controllers on p. 88.
- Power supply AC 230V power supply with the option of galvanically isolated relay output contacts from the power supply

Instrument description

Configurable button descriptions

Service LED + Ambient light sensor

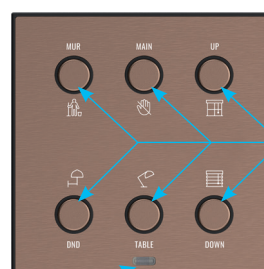

Buttons for Wireless devices

Hidden pairing button

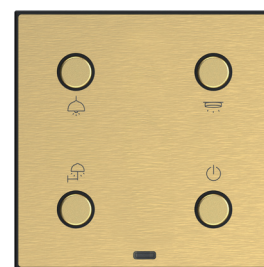

Connection

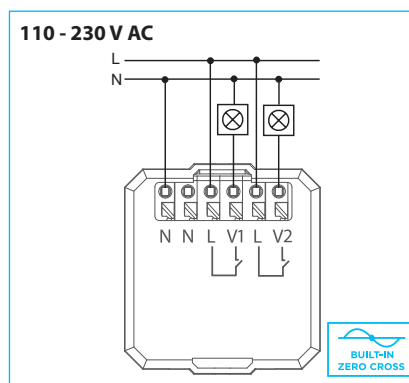

Output contact V1 is at the same potential as the product power supply. Output contact V2 is separate from the power supply but must be connected to the same potential. The wiring is used when it is necessary to secure V1 and V2 separately.

BUILT-IN ZERO CROSS

Output relays are equipped with ZERO CROSS technology, which allows switching the load when the voltage passes zero, i.e. in the minimum current consumption, which prevents burning and sticking of relay contacts - especially when switching electronic ballasts, which are part of each LED luminaire.



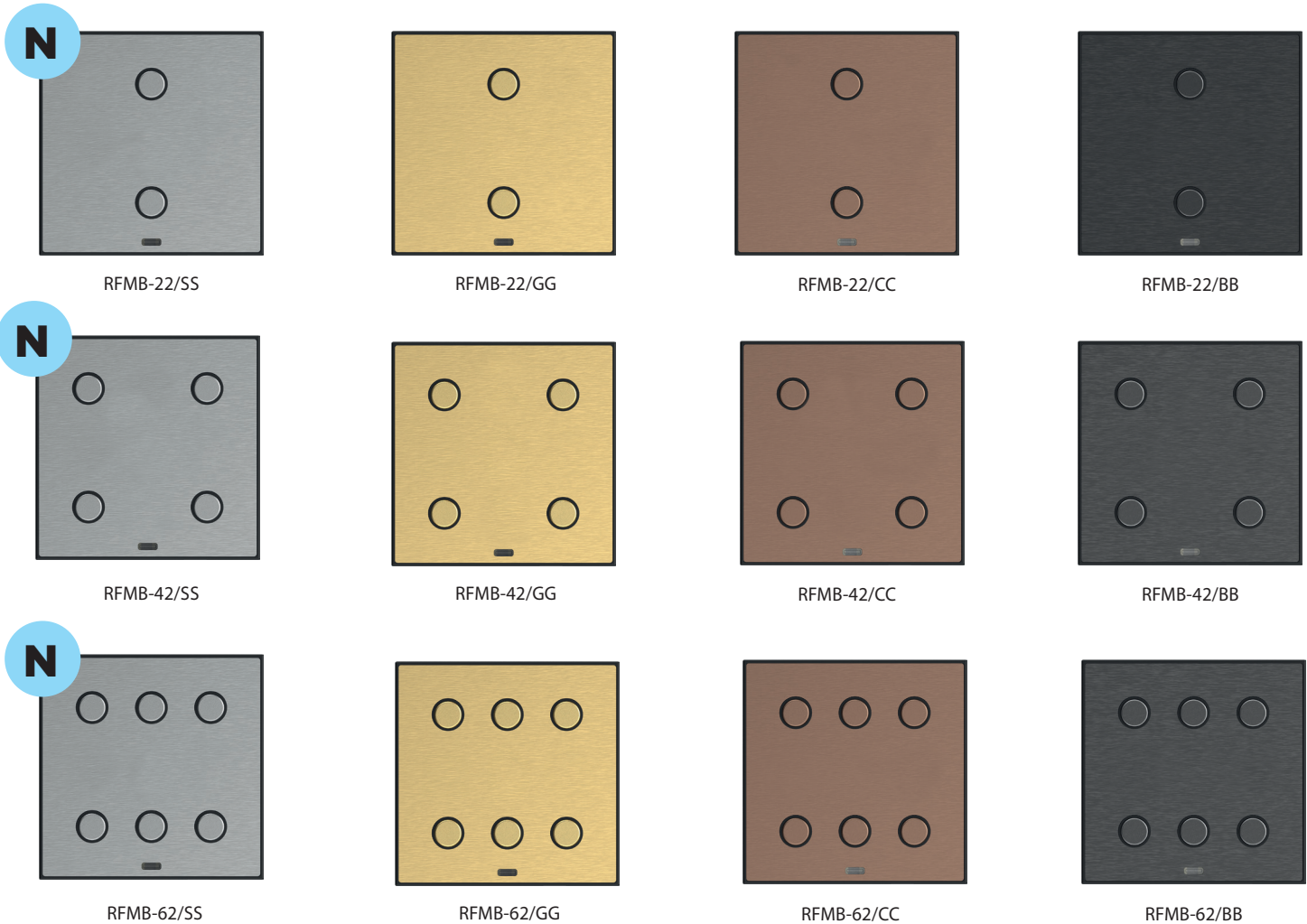

Type	EAN	Code
RFMB-22/CC	8595188195522	9552
RFMB-42/CC	8595188195515	9551
RFMB-62/CC	8595188195508	9550
RFMB-22/GG	8595188195492	9549
RFMB-42/GG	8595188195485	9548
RFMB-62/GG	8595188195478	9547
RFMB-22/SS	8595188195461	9546
RFMB-42/SS	8595188195454	9545
RFMB-62/SS	8595188195447	9544
RFMB-22/BB	8595188195423	9542
RFMB-42/BB	8595188195409	9540
RFMB-62/BB	8595188194907	9490

RFMB-x2/xx

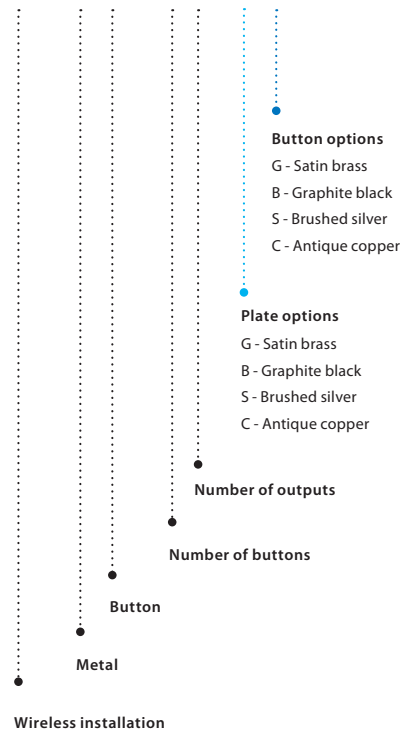



Technical parameters	RF Pilot/W	RF Pilot/A
Display		
Type:	colour OLED	
Resolution:	128 x 128 pixels	
Side ratio:	1:1	
Visible surface:	26 x 26 mm	
Backlighting:	self-illuminating text	
Diagonal:	1.5"	
Control:	direction button, control buttons	
Power supply		
Power supply:	2 x 1.5 V AAA batteries/R03	
Battery life:	approx. 3 years, according to the frequency of use and battery type	
Control		
Range:	in open space up to 200 m	
Communication protocol:	RFIO	
Frequency:	866–922 MHz (for more information see p. 85)	
Other data		
Operating temperature:	0 to +55 °C	
Storage temperature:	-20 to +70 °C	
Colour design:	white	anthracite
Protection:	IP20	
Operating position:	any	
Dimensions:	130 x 41 x 18 mm	
Weight:	61 g	
Related standards:	EN 60730, EN 63044, EN 300 220, EN 301 489	

RF Pilot

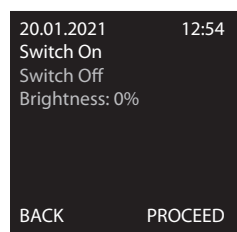
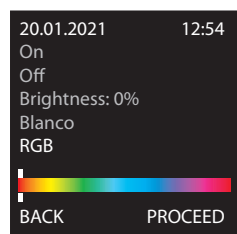

- The Remote Wireless controller with display is a central controller for switching electrical appliances and equipment, dimming lights, controlling blinds, etc.
- Designed in white and anthracite with colour OLED display.
- 4 directional joystick + 2 buttons for intuitive operation.
- Option of setting light scenes, where with a single press, you can control up to 10 units at once.
- Display of room temperature, battery status, date and time directly on display.
- The Favorites mode lets you preset the most frequently used devices on the home screen.
- Bidirectional communication, transmits and receives commands and displays the status of units.
- Thanks to the function of measuring the signal between the controller and unit, you can use it for testing the range and signal quality.
- Battery power (2x 1.5 V AAA batteries - included in supply) with battery life of around 3 years based on frequency of use and type of batteries.
- Range up to 200 m (in open space), if the signal is insufficient between the controller and unit, use the signal repeater RFRP-20N or protocol component RFIO2 that support this feature.

Device description

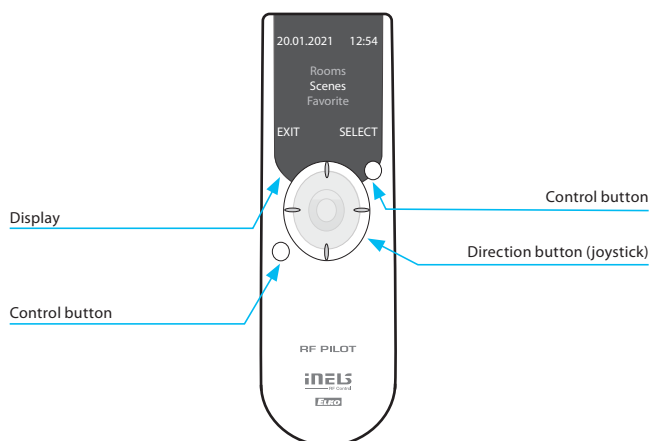

Display description

Colour LED display

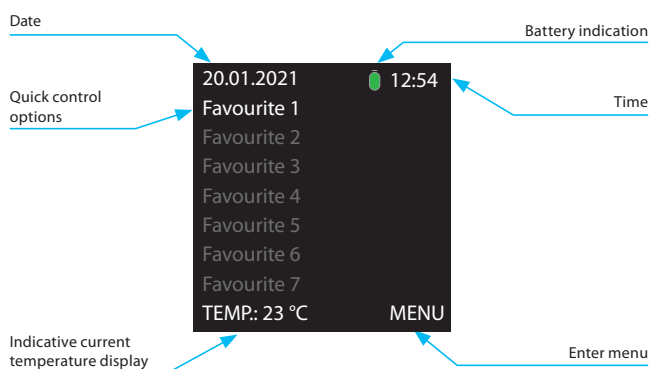

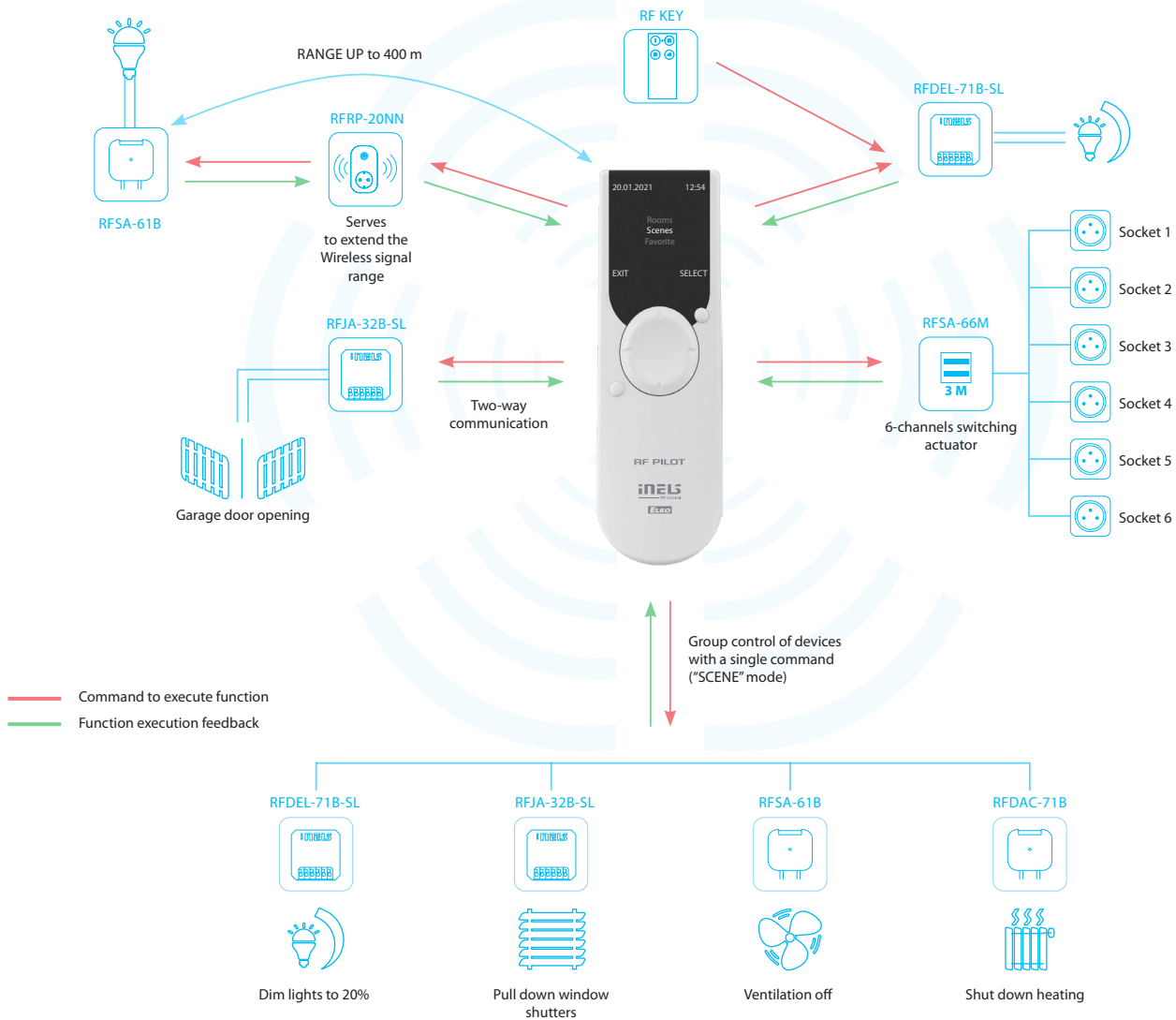

SCENES

- serves to control actuators as a group with a single touch
- possibility to set up scenes; on activation, for example, window shutters are pulled down and the light will adjust to the required brightness

WINDOW SHUTTERS

- controlling window shutters, blinds, garage door, etc.
- window shutters are controlled separately or as a group
- the window shutter receivers are powered by either 230 V or 24 V DC (shutters between windows)

FAVOURITE

- serves to select the most frequently used devices
- on display activation, the "Favourite" menu pops up automatically to provide you with a quick access to controlling devices

SWITCHING

- this function serves to switch on/off lights, sockets, electrical appliances and devices
- intuitive control thanks to customized name options
- switching actuator function selections: switch on/off, impulse relay, button, delayed ON/OFF (time of delay from 2 seconds to 60 minutes)
- function description can be found on p. 82

DIMMING

- the regulation of light intensity (light bulbs, LED strips, halogen lights with electrical or coil transformer, fluorescent tubes with dimmable ballast 1–10 V)
- customizable names of individual dimmed circuits (such as "lights" or "living room")
- "sunrise/sunset" imitation - light gradually goes on or off during the preset period between 2 seconds and 30 minutes
- function description can be found on p. 82



EAN code:
 RF KEY-40/W: 8595188180740 RF KEY-60/W: 8595188180764
 RF KEY-40/B: 8595188180757 RF KEY-60/B: 8595188180771

Technical parameters	RF KEY-40	RF KEY-60
Supply voltage:	3 V CR 2032 battery	
Battery life:	around 5 years based on frequency of use	
Transmission indication:	red LED	
Number of buttons:	4	6
Communication protocol:	RFIO	
Transmitter frequency:	866–922 MHz (for more information see p. 85)	
Signal transmission method:	unidirectionally addressed message	
Range:	in open space up to 200 m	
Other data		
Operating temperature:	-10 to +50 °C	
Operating position:	any	
Colour design:	white, black	
Protection:	IP20	
Contamination degree:	2	
Dimensions:	64 x 25 x 10 mm	
Weight:	16 g	
Related standards:	EN 60730, EN 63044, EN 300 220, EN 301 489	

- Key fob – sized remote control, available in black and white.
- When pressing the button, it sends a set signal (ON/OFF, dimming, time switching OFF/ON, blinds up/down).
- **RF KEY-40:** four buttons enable control of four units independently.
- **RF KEY-60:** six buttons enable control of four units independently.
- Battery power supply (3 V CR 2032 battery - included in the supply) with battery life of around 5 years based on frequency of use.
- Attention: The controller is paired with the elements using the pairing button. Ord. codes for controllers with pairing button: RF KEY-40/W Order No.: 8504, RF KEY-40/B Order No.: 8503, RF KEY-60/W Order No.: 8505, RF KEY-60/B Order No.: 8490, see Pairing controllers on p. 88.

Device description

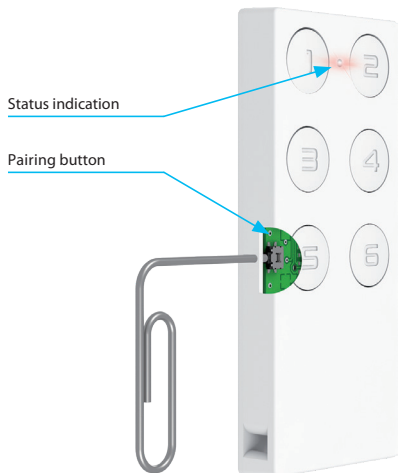
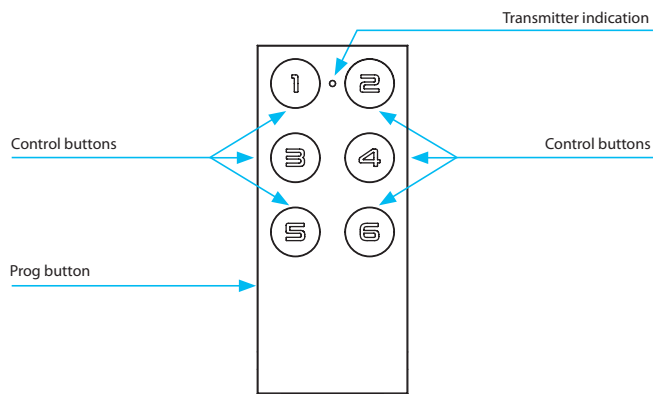

Variants

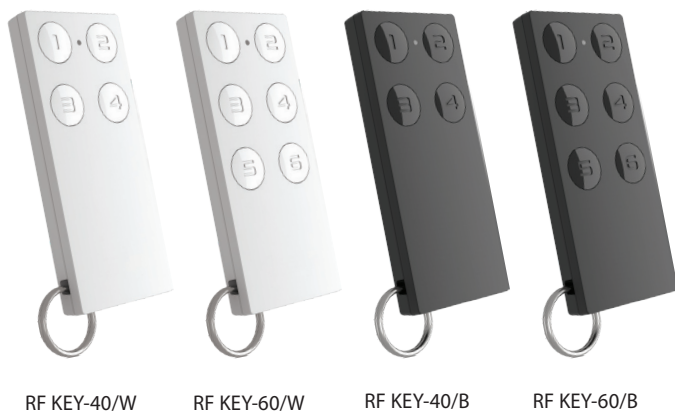

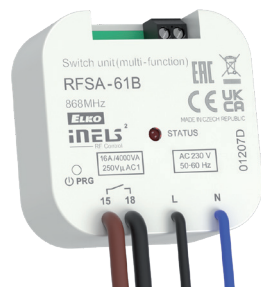

EAN code:
RFSA-61B: 8595188136242

Technical parameters	RFSA-61B/230V
Supply voltage:	230 V AC
Supply voltage frequency:	50–60 Hz
Apparent input:	7 VA/cos φ= 0.1
Dissipated power:	0.7 W
Supply voltage tolerance:	+10 %; -15 %
Output	
Number of contacts:	1x NO, non potencial
Rated current:	16 A/AC1
Switching power:	4000 VA/AC1, 384 W/DC
Peak current:	30 A/<3 s
Switching voltage:	250 V AC1/24 V DC
Max. DC switching power:	500 mW
Mechanical service life:	3x 10 ⁷
Electrical service life (AC1):	0.7x 10 ⁵
Control	
Wireless:	up to 25-channels (buttons)
Communication protocol:	RFIO2
Frequency:	866–922 MHz (for more information see p. 85)
Repeater function:	yes
Manual control:	button PROG (ON/OFF)
Range:	in open space up to 200 m
Other data	
Operating temperature:	-15 to +50 °C
Operating position:	any
Mounting:	free at lead-in wires
Protection:	IP30
Overvoltage category:	III.
Contamination degree:	2
Terminals (CY wire, cross-section):	2x 0.75 mm ² , 2x 2.5 mm ²
Length of terminals:	90 mm
Dimensions:	49 x 49 x 21 mm
Weight:	46 g
Related standards:	EN 60730, EN 63044, EN 300 220, EN 301 489

- The switching unit with 1 output channel 16 A is used to control appliances, lights (easy to integrate it to control garage doors or gates).
- They can be combined with detectors, controllers, iNELS Wireless or system components.
- **RFSA-61B:** multifunction design – button, impulse relay and time function of delayed ON or OFF with time setting of 2 s – 60 min. Function description can be found on p. 86.
- The switching unit may be controlled by up to 25-channels.
- The programming button on the unit is also used for manual control of the output.
- Memory status can be pre-set in the event of a power failure.
- Range up to 200 m (in open space), if the signal is insufficient between the controller and unit, use the signal repeater RFRP-20N or protocol component RFIO2 that support this feature.
- The BOX design lets you mount it right in an installation box, a ceiling or controlled appliance cover.

Device description

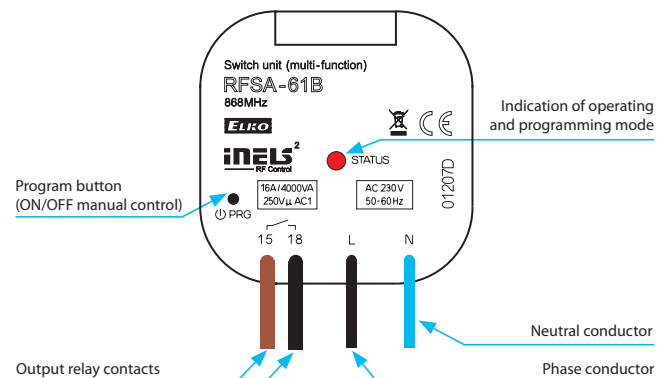

Connection

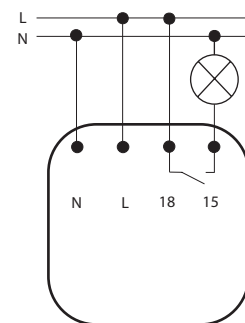

N

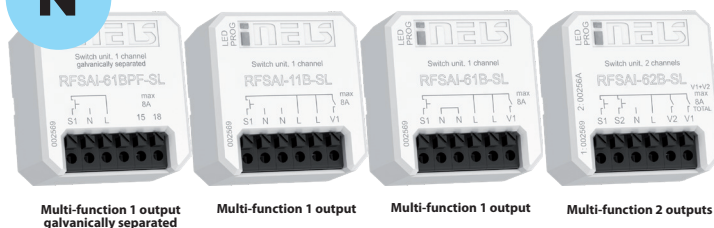

EAN code:
 RFSAI-61BPF-SL: 8595188189101
 RFSAI-11B-SL: 8595188183758
 RFSAI-61B-SL: 8595188182041
 RFSAI-62B-SL: 8595188182010

Technical parameters

	RFSAI-61BPF-SL	RFSAI-11B-SL	RFSAI-61B-SL	RFSAI-62B-SL
Supply voltage:	230 V AC			
Supply voltage frequency:	50-60 Hz			
Apparent input:	7 VA / $\cos \varphi = 0.1$			
Dissipated power:	0.7 W			
Supply voltage tolerance:	+10%; -15 %			

Output

	1x switching	2x switching
Number of contacts:	1x switching	2x switching
Rated current:	8 A / AC1	
Switching power:	2000 VA / AC1	
Peak current:	I _{peak} < 110A 300us / max. input capacity 125 uF	
Switching voltage:	250 V AC1	
Mechanical service life:	1x10 ⁷	
Electrical service life (AC1):	1x10 ⁵	

Control

	25-channels	2 x 12-channels
Wireless:	25-channels	2 x 12-channels
Number of functions:	6	1
Communication protocol:	RFIO2	
Frequency:	866-922 MHz (for more information see p. 85)	
Repeater function:	yes	
Manual control:	button PROG (ON/OFF)	
External button / switch:	yes	
Range:	in open space up to 200 m	

Other data

Operating temperature:	-15 to + 50 °C	
Operating position:	any	
Mounting:	free at lead-in wires	
Protection:	IP40	
Overvoltage category:	III.	
Contamination degree:	2	
Connection:	screwless terminals	
Connecting conductor:	0.2-1.5 mm ² solid/flexible	
Dimensions:	43 x 44 x 22 mm	
Weight:	31g	45 g
Related standards:	EN 60730, EN 63044, EN 300 220, EN 301 489	

Function description

1. Button, impulse relay and time functions of delayed start or return with time setting 2 s-60 min. Any function can be assigned to each output relay.
2. The programming button on the element also serves as a manual input control.

- The switching component with one/two output relays is used to control appliances and lights. Switches/buttons connected to the wiring can be used for control.
- They can be combined with Detectors, Controllers or iNELS Wireless System Components.
- The BOX-SL version offers installation directly in the installation box, ceiling or cover of the controlled appliance. Easy installation thanks to screwless terminals.
- It allows the connection of switched loads with a total sum of 8 A (2,000 W).
- Switching element RFSAI-61BPF-SL has galvanically isolated terminals (potential-free contact)
- Functions: for RFSAI 61B-SL and RFSAI 62B-SL - pushbutton, impulse relay and time functions of delayed start or return with time setting 2 s-60 min. Any function can be assigned to each output relay. For RFSAI-11B-SL, the button has a fixed function - ON / OFF. Function description can be found on p. 86.
- The external button is assigned in the same way as the wireless one.
- Each of the outputs can be controlled by up to 12/12 channels (1-channel represents one button on the controller). Up to 25 channels for RFSAI-61B-SL and RFSAI-11B-SL.
- The programming button on the component also serves as a manual output control.
- Possibility to set the output status memory in case of failure and subsequent power recovery.
- The elements of the repeater can be set for the components via the RFAF / USB service device, PC, application.
- Range up to 200 m (outdoors), in case of insufficient signal between the controller and the device, use the RFRP-20N signal repeater or component with the RFIO2 protocol that support this function.
- Communication with bidirectional RFIO2 protocol.
- The contact material of the AgSnO₂ relay enables switching of light ballasts.

Device description

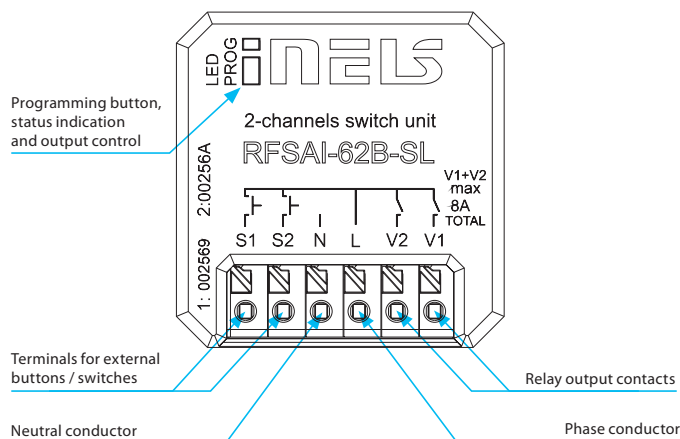

Connection

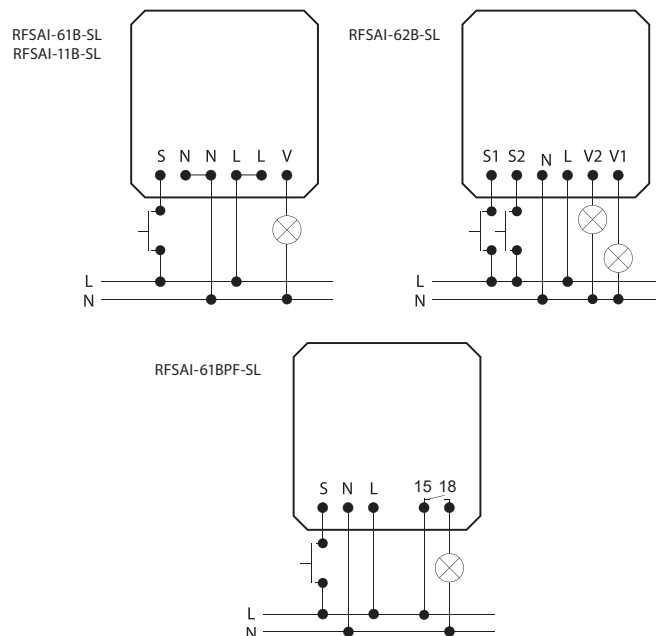

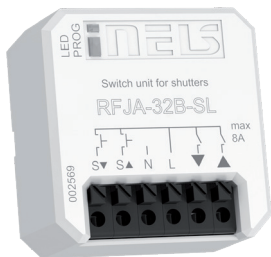

EAN code:
RFJA-32B-SL: 8595188182546

Technical parameters	RFSAI-32B-SL
Supply voltage:	230 V AC
Supply voltage frequency:	50-60 Hz
Apparent input:	7 VA / $\cos \varphi = 0.1$
Dissipated power:	0.7 W
Supply voltage tolerance:	+10 %; -15 %
Output	
Number of contacts:	2x switching
Rated current:	8 A / AC1
Switching power:	2000 VA / AC1
Peak current:	10 A / <3 s
Switching voltage:	250 V AC1
Mechanical service life:	1x10 ⁷
Electrical service life (AC1):	1x10 ⁵
Control	
Wireless:	25-channels
Communication protocol:	RFIO2
Frequency:	866-922 MHz (for more information see p. 85)
Repeater function:	yes
Manual control:	PROG (ON/OFF) button
External button / switch:	max. 100 m cable
Range:	in open space up to 200 m
Other data	
Operating temperature:	-15 to + 50 °C
Operating position:	any
Mounting:	free at lead-in wires
Protection:	IP30
Overvoltage category:	III.
Contamination degree:	2
Connecting conductor cross-section (mm ²):	0.2 - 1.5 mm ² solid / flexible
Dimensions:	43 x 44 x 22 mm
Weight:	45 g
Related standards:	EN 60730, EN 63044, EN 300 220, EN 301 489

- The switching unit for shutters has 2 output channels used to control garage doors, gates, blinds, awnings...
- They can be combined with Controllers or iNELS Wireless System Components.
- The BOX version offers mounting directly in the installation box, ceiling or motor drive cover.
- RFJA-32B-SL: connection of switched load 2x 8 A (2x 2000 W), with the possibility of connecting existing wire buttons.
- Short presses of the controller allow tilting of the slats, long pressing of the raise / lower moves the blinds to the end position.
- Each component can be controlled by up to 25 channels (1 channel represents one assigned controller).
- The programming button on the device also serves as a manual output control.
- For components, the repeater function can be set via the RFAF / USB service device.
- Range up to 200 m (outdoors), in case of insufficient signal between the controller and the device, use the RFRP-20N signal repeater or components with the RFIO2 protocol that support this function.
- The contact material of the AgSnO₂.

Device description

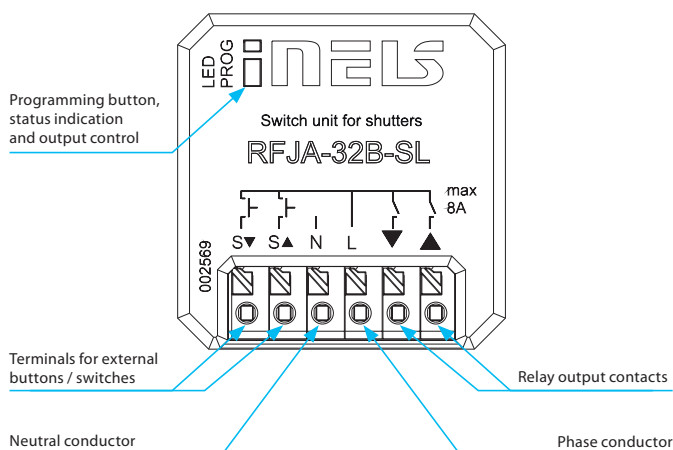

Function description

1. As long as the button on the remote control is pressed for <2 s, the blinds move upwards (▲) or downwards (▼).
2. When the button is pressed for > 2 s, the blinds move upwards (▲) or downwards (▼) to the end position.

Connection

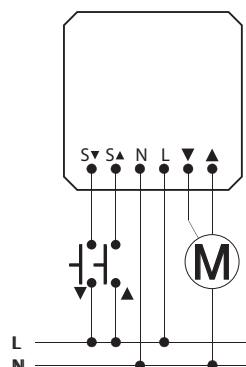



EAN code:
RFSA-61MI: 8595188181549
RFSA-61M: 8595188137003

Technical parameters	RFSA-61MI/230V	RFSA-61M/230V
Supply voltage:	110–230 V AC	
Supply voltage frequency:	50–60 Hz	
Apparent input:	2.7 VA $\cos \varphi = 0.6$	
Dissipated power:	1.62 W	
Supply voltage tolerance:	+10%/-25 %	
Output		
Number of contacts:	1x changeover	
Rated current:	16 A/AC1	
Switching power:	4000 VA/AC1, 384 W/DC	
Peak current:	30 A/<3 s	
Switching voltage:	250 V AC1/24 V DC	
Contact material:	AgSnO ₂	
Mechanical service life:	3x10 ⁷	
Electrical service life (AC1):	0.7x10 ⁵	
Control		
Wireless:	up to 25-channels (buttons)	
Communication protocol:	RFIO2	
Frequency:	866–922 MHz (for more information see p. 85)	
Repeater function:	yes	
Manual control:	PROG (ON/OFF) button	
Range:	in open space up to 200 m	
Wireless Antenna:	integrated	external *
Other data		
Operating temperature:	-15 °C to +50 °C	
Operating position:	any	
Mounting:	DIN rail EN 60715	
Protection:	IP20 from the front panel	
Overvoltage category:	III.	
Contamination degree:	2	
Connecting conductor cross-section (mm ²):	max. 1x 2.5, max. 2x 1.5/ with a hollow max. 1x 2.5	
Dimensions:	90 x 17.6 x 64 mm	
Weight:	69 g	75 g
Related standards:	EN 60730, EN 63044, EN 300 220, EN 301 489	

* AN-I antenna (with SMA connector) is part of packaging.
Other antennas with cable are available on the p. 76.
Max tightening torque for antenna's connector is 0.56 Nm.

- **RFSA-61M:** the switching unit with 1 output channel 16 A is used for controlling appliances, sockets or lights.
 - the 1-MODULE design of the unit into a switchboard.
 - the switching unit may be controlled by up to 25-channels.
 - the package includes an internal antenna AN-I, in case of locating the element in a metal switchboard, you can use the external antenna AN-E for better signal reception, see accessories on p. 75.
- **RFSA-61MI:** same design and function as RFSA-61M, but with integrated antenna. It is suitable for placement in cabinets with plastic doors.
- 6 function: button, impulse relay and time function of delayed start or return with time setting range of 2 s – 60 min. Function description can be found on p. 76.
- The programming button on the unit is also used for manual control of the output.
- Memory status can be pre-set in the event of a power failure.

Device description

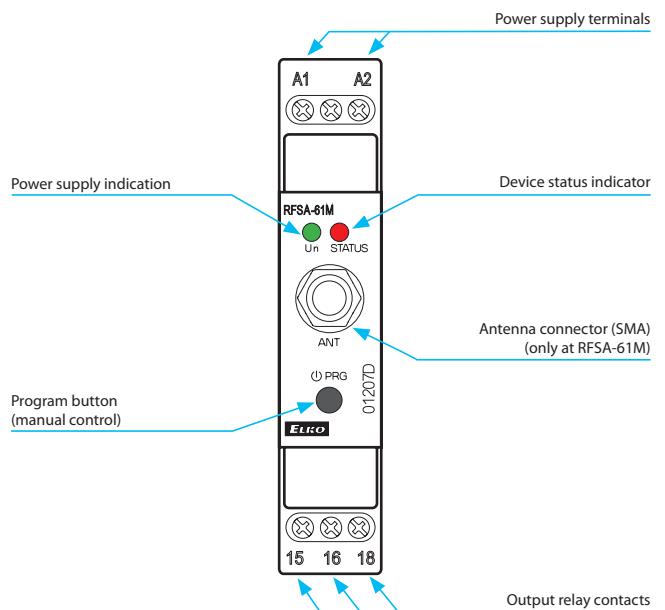

Connection





EAN code:
 RFS-66MI/230V: 8595188181563 RFS-66M/230V: 8595188137003
 RFS-66MI/24V: 8595188181563 RFS-66M/24V: 8595188152914

Technical parameters	RFS-66MI/230V	RFS-66MI/24V	RFS-66M/230V	RFS-66M/24V
Supply voltage:	110–230 V AC	12–24 V AC/DC	110–230 V AC	12–24 V AC/DC
SELV:	no	yes	no	yes
Supply voltage frequency:	AC 50–60 Hz			
Apparent input:	min. 2 VA/ max. 5 VA	-	min. 2 VA/ max. 5 VA	-
Dissipated power:	min. 0.5W/ max. 2.5W	max. 1.8 W	min. 0.5W/ max. 2.5W	max. 1.8 W
Supply voltage tolerance:	+10%/-15 %			
Output				
Number of contacts:	3x ECO, 3x NO			
Rated current:	8 A/AC1			
Switching power:	2000 VA/AC1			
Peak current:	10 A/<3 s			
Switching voltage:	250 V AC1			
Contact material:	AgSnO ₂			
Mechanical service life:	1x10 ⁷			
Electrical service life (AC1):	1x10 ⁵			
Control				
Wireless:	up to 25-channels (buttons)			
Communication protocol:	RFIO2			
Frequency:	866–922 MHz (for more information see p. 85)			
Repeater function:	yes			
Manual control:	PROG (ON/OFF) button			
Range:	in open space up to 200 m			
Wireless Antenna:	integrated		external *	
Other data				
Operating temperature:	-15 °C to +50 °C			
Operating position:	any			
Mounting:	DIN rail EN 60715			
Protection:	IP20 from the front panel			
Overvoltage category:	III.			
Contamination degree:	2			
Connecting conductor cross-section (mm ²):	max. 1x 2.5, max. 2x 1.5/ with a hollow max. 1x 2.5			
Dimensions:	90 x 52 x 65 mm			
Weight:	171 g		179 g	
Related standards:	EN 60730, EN 63044, EN 300 220, EN 301 489			

- **RFS-66M:** the switching unit with 6 output channels 8 A is used for independent control of up to 6 appliances, sockets or lights.
 - the 3-MODULE design of the unit into a switchboard.
 - each of the channels may be controlled by up to 25-channels.
 - the package includes an internal antenna AN-I, in case of locating the element in a metal switchboard, you can use the external antenna AN-E for better signal reception, see accessories on p. 76.
- **RFS-66MI:** same design and function as RFS-66M, but with integrated antenna. It is suitable for placement in cabinets with plastic doors.
- **6 function:** button, impulse relay and time function of delayed start or return with time setting range of 2 s – 60 min. Function description can be found on p. 86.
- The programming button on the unit is also used for manual control of the output.
- Memory status can be pre-set in the event of a power failure.

Device description

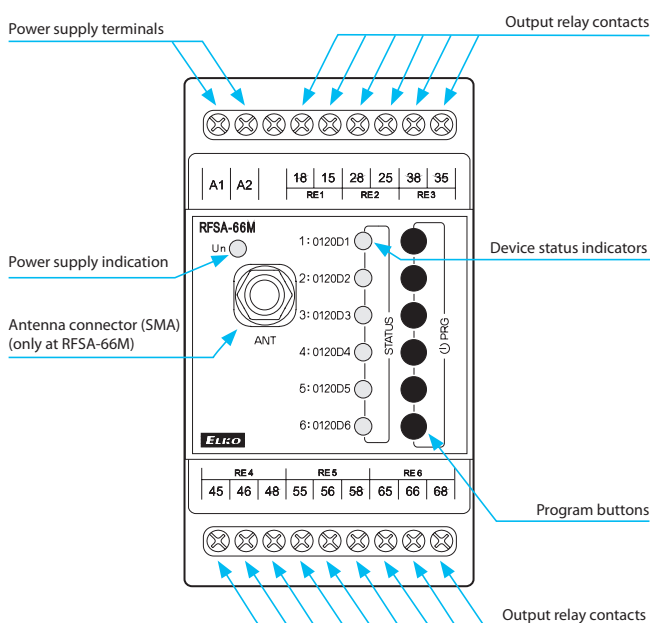

Connection

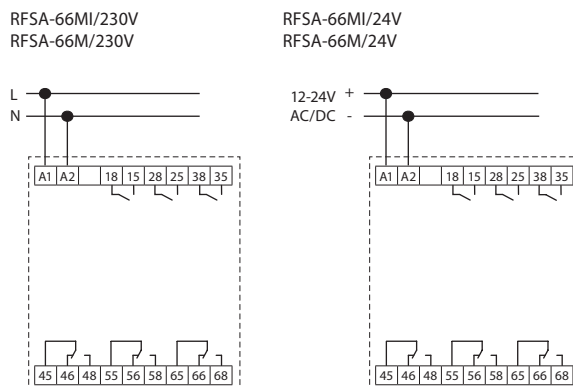

* AN-I antenna (with SMA connector) is part of packaging. Other antennas with cable are available on the p. 85. Max tightening torque for antenna's connector is 0.56 Nm.



EAN code:

RFUS-61/230V: 8595188145268

RFUS-61/120V: 8595188152570

Technical parameters		RFUS-61/230V
Supply voltage:		230 V AC
Supply voltage frequency:		50–60 Hz
Apparent power:		5 VA/cos φ= 0.1
Dissipated power:		0.6 W
Supply voltage tolerance:		+10 %; -15 %
Output		
Rated current:		1x switching (AgSnO ₂)
Number of contacts:		12 A/AC1
Switching power:		3000 VA/AC1, 384 W/DC
Peak current:		30 A/<3 s
Switching voltage:		250 V AC1/24 V DC
Min. switching power DC:		500 mW
Mechanical service life:		3x10 ⁷
Electrical service life (AC1):		0.7x10 ⁵
Control		
Wireless:		up to 25-channels (buttons)
Communication protocol:		RFIO2
Frequency:		866–922 MHz (for more information see p. 85)
Repeater function:		yes
Manual control:		PROG (ON/OFF) button
Range:		in open space up to 200 m
Other data		
Operating temperature:		-15 to +50 °C
Operating position:		any
Mounting:		screws
Protection:		IP65
Overvoltage category:		III.
Contamination degree:		2
Cross-section of connecting wires (mm ²):		max. 1x 2.5, max. 2x 1.5/ with a hollow max. 1x 2.5
Recommended power cord:		CYKY 3x1.5 (CYKY 4x1.5)
Dimensions:		136 x 62 x 34 mm
Weight:		146 g
Related standards:		EN 60730, EN 63044, EN 300 220, EN 301 489

- The switching unit with 1x 12 A output channel is used for controlling appliances, sockets or lights.
- They can be combined with detectors, controllers, iNELS Wireless or system components.
- Multi-function design – button, impulse relay and time function of delayed ON or OFF with time setting of 2 s – 60 min. Function description can be found on p. 86.
- The switching unit may be controlled by up to 25-channels.
- The programming button on the unit is also used for manual control of the output.
- Range up to 200 m (in open space), if the signal is insufficient between the controller and unit, use the signal repeater RFRP20 or protocol component RFIO2 that support this feature.
- Communication frequency with bidirectional protocol RFIO2.

Device description

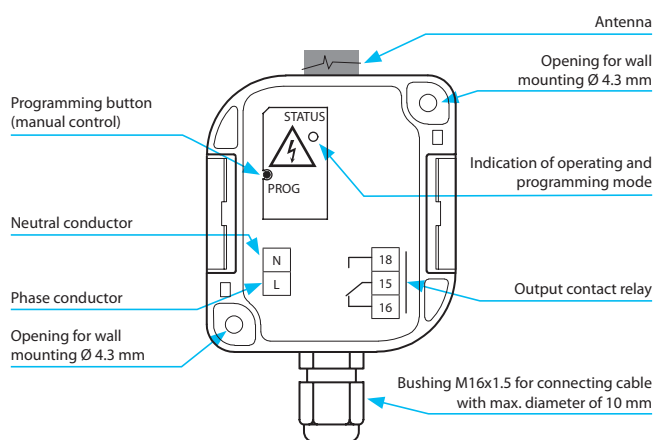

Connection

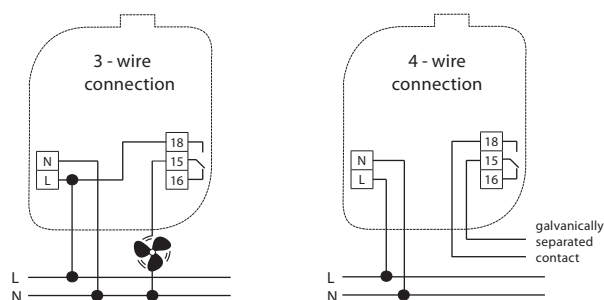



EAN code:
 RFSC-61N/Schuko: 8595188182508 RFSC-61N/British: 8595188182522
 RFSC-61N/French: 8595188182515

Technical parameters **RFSC-61N/230V**

Supply voltage:	230 V AC
Supply voltage frequency:	50-60 Hz
Apparent power:	7 VA / $\cos \varphi = 0.1$
Dissipated power:	0.7 W
Supply voltage tolerance:	+10 %; -15 %

Output	
Number of contacts:	1x switching
Rated current:	16 A / AC1
Switching power:	4000 VA / AC1
Peak current:	30 A / <3 s
Switching voltage:	250 V AC1
Min. switching power DC:	500 mW
Mechanical service life:	10x10 ⁶
Electrical service life (AC1):	0.7x10 ⁵

Control	
Wireless:	up to 32-channels (buttons)
Communication protocol:	RFIO2
Frequency:	866-922 MHz (for more information see p. 85)
Repeater function:	no
Manual control:	button PROG (ON/OFF)
Range:	in open space up to 200 m

Other data	
Operating temperature:	-15 to + 50 °C
Working position:	any
Mounting:	plug into a socket
Protection:	IP30
Overvoltage category:	III.
Contamination degree:	2
Dimensions:	63 x 110 x 74 mm
Weight:	129 g
Related standards:	EN 60730, EN 63044, EN 300 220, EN 301 489

- The switched socket is used to control fans, lamps, direct heaters and appliances, which are connected by a power cord with a plug up to 16 A.
- They can be combined with detectors, controllers or iNELS Wireless system components.
- Multifunctional design - button, impulse relay and time functions of delayed start or return with time setting 2 s - 60 min. (see p. 86)
- The switched socket can be controlled by up to 32 channels.
- The programming button on the socket also serves as a manual output control with indication.
- Possibility to set the output status memory in case of failure and subsequent power recovery.
- Range up to 200 m (outdoors) (in case of insufficient signal between the controller and the device, use the RFRP-20N signal repeater) or components with the RFIO2 protocol that support this function.
- Thanks to the socket design, installation is simple and straightforward by plugging it into an existing socket.
- The contact material of the AgSnO2 relay enables switching of light ballasts.

Produced in 3 designs of sockets/plugs:



Device description

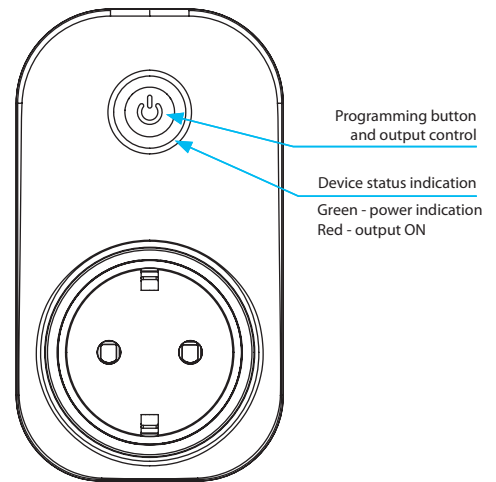

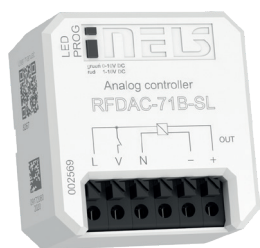

EAN code:
RFDAC-71B: 8595188182676

Technical parameters	RFDAC-71B
Supply voltage:	110–230 V AC
Supply voltage frequency:	50–60 Hz
Apparent input:	7 VA / $\cos \varphi = 0.1$
Dissipated power:	0.7 W
Supply voltage tolerance:	+10/-15 %

Control

Potential-free analog output/max. current:	0(1)–10 V/10 mA
Rated current:	1x AgSnO ₂ , switches the phase conductor
Rated current:	8 A/AC1
Switching power:	2 000 VA/AC1
Switching voltage:	250 V AC1
Mechanical service life:	3x10 ⁷
Electrical service life:	1x10 ⁵
Indication:	red LED/green LED
Output selection:	0(1)–10V/PROG button

Control

Wireless:	up to 25-channels (buttons)
Communication protocol:	RFIO2
Frequency:	866–922 MHz (for more information see p. 85)
Repeater function:	yes
Manual control:	button PROG (ON/OFF)
Range:	in open space up to 200 m
Minimal control distance:	20 mm

Other data

Operating temperature:	-15 to +50 °C
Operating position:	any
Mounting:	plug into a socket
Protection:	IP40
Overvoltage category:	III.
Contamination degree:	2
Terminals (CY wire, cross-section):	3 x 0.75 mm ² , 2 x 2.5 mm ²
Dimensions:	49 x 49 x 21 mm
Weight:	43 g
Related standards:	EN 60730, EN 63044, EN 300 220, EN 301 489

- The device with analog output 0(1)–10 V is used to control devices, luminaires, thermal actuators and thermal heads – which are equipped with such an input.
- They can be combined with detectors, controllers, iNELS Wireless or system components.
- Potential free analog output 0(1)–10 V, contact relay 8 A.
- 7 light functions – smooth increase or decrease with time setting 2 s–30 min. Function description can be found on p. 86.
- The analog controller may be controlled by up to 25-channels.
- The programming button on the controller is also used for manual control of the output.
- Memory status can be pre-set in the event of a power failure.
- Range up to 200 m (in open space), if the signal is insufficient between the controller and unit, use the signal repeater RFRP-20N or protocol component RFIO2 that support this feature.
- The BOX design lets you mount it right in an installation box, a ceiling or light cover.

Device description

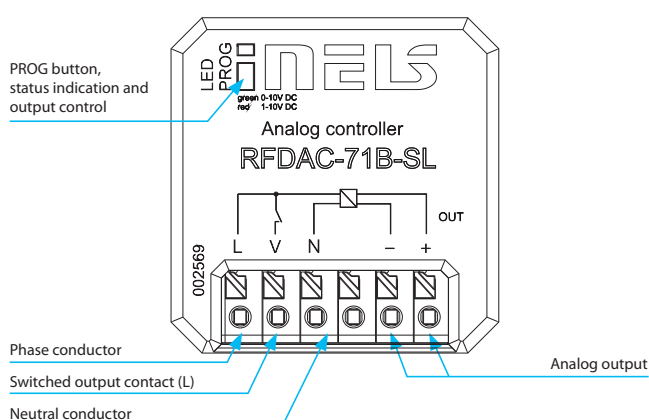

Connection

Connection example: dimming of fluorescent tubes with dimmable ballast

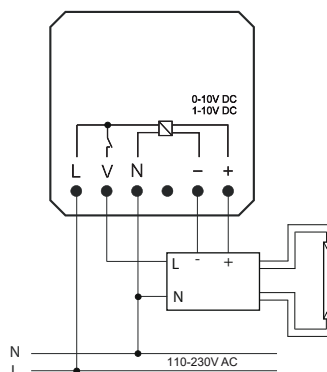

Connection example: with thermo valve

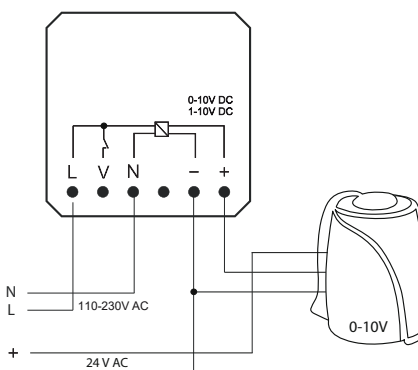

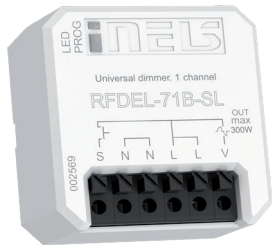

EAN code:
RFDEL-71B-SL: 8595188183611

Technical parameters		RFDEL-71B-SL/230V
Supply voltage:		230 V AC / 50 Hz
Supply voltage frequency:		50-60 Hz
Apparent power:		5 VA / $\cos \varphi = 0.1$
Dissipated power:		0.5 W
Supply voltage tolerance:		+10/-15 %
Connection:		4-wire, with "NEUTRAL"
Output		
Dimmed load:		R, L, C, LED, ESL
Contactless:		2 x MOSFET
Load capacity:*		max. 300 W*
Control		
Wireless:		up to 25-channels (buttons)
Communication protocol:		RFIO2
Frequency:		866-922 MHz (for more information see p. 85)
Repeater function:		yes
Range:		up to 200 m
Manual control:		tlačítko PROG (ON/OFF)
External button / switch:		yes
Other data		
Operating temperature:		-15 to + 45 °C
Working position:		any
Mounting:		free at lead-in wires
Protection:		IP40
Overvoltage category:		III.
Contamination degree:		2
Connection:		screwless terminals
Connecting conductor:		0.2-1.5 mm ² solid/flexible
Dimensions:		43 x 44 x 22 mm
Weight:		30 g
Related standards:		EN 60730, EN 63044, EN 300 220, EN 301 489

- Universal built-in dimmer is used to regulate light sources:
R – classic light bulbs,
L – halogen bulbs with wound transformer,
C – halogen bulbs with electronic transformer,
ESL – dimmable energy saving lamps,
LED – LED light sources (230 V).
- They can be combined with Detectors, Controllers or iNELS Wireless System Elements.
- 7 light functions - smooth start or stop with time setting 2 s-30 min., function description p. 86.
- Min. brightness eliminates flickering LED and ESL light sources.
- The universal dimmer can be controlled by up to 25 channels
- Control input "S" for connecting an existing wired button.
- The programming button on the device also serves as a manual output control.
- Possibility to set memory status in case of power failure.
- The repeater function of the components can be set via the RFAF / USB service device.
- Range up to 200 m (outdoors), in case of insufficient signal between the controller and the component, use the RFRP-20N signal repeater or components with the RFIO2 protocol that support this function.
- The BOX version offers mounting directly in the installation box, ceiling or luminaire cover.

Device description

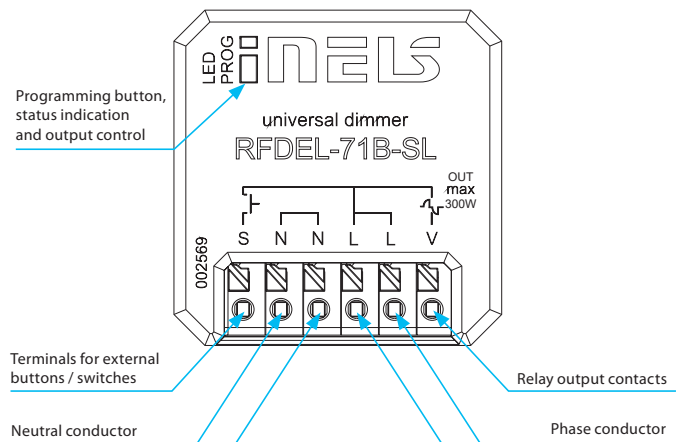

Connection

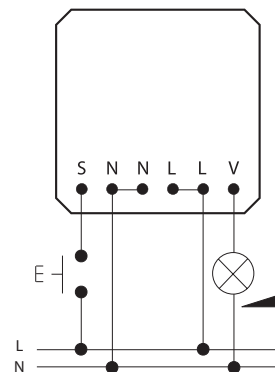

Types of connectable loads

R resistive	L inductive	C capacitive	LED light	ESL saving

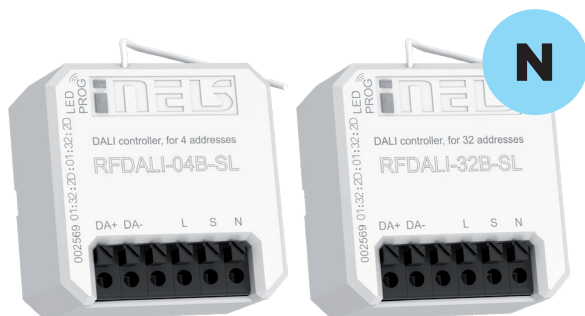

EAN code:
RFDALI-04B-SL: 8595188185271

RFDALI-32B-SL: 8595188184342

Technical parameters	RFDALI-04B-SL RFDALI-32B-SL
Supply voltage:	100-230 V AC / 50 Hz
Supply voltage frequency:	50/60 Hz
Apparent power:	5 VA / $\cos \varphi = 0.1$
Dissipated power:	3 W
Supply voltage tolerance:	+10/-15 %
Connection:	4-wire, L, N, DA+, DA-
Output DALI	
Number of devices:	max. 4 max. 32
Power supply:	16V/100 mA
Control	
Wireless:	32-channels
Communication protocol:	iNELS Wireless
Frequency:	866-922 MHz (for more information see p. 85)
Repeater function:	yes
Range:	up to 200 m
Manual control:	button PROG (ON/OFF)
External button / switch:	yes
Configuration	
Interface	WiFi AP 2.4 GHz, webserver
Application	Internet browser
Other data	
Operating temperature:	-15 to + 50 °C
Working position:	any
Mounting:	free at lead-in wires
Protection:	IP40
Overvoltage category:	III.
Contamination degree:	2
Connection:	screwless terminals
Connecting conductor:	0.2-1.5 mm ² solid/flexible
Dimensions:	43 x 44 x 22 mm
Weight:	52g
Related standards:	EN 60730, EN 63044, EN 300 220, EN 301 489, EN 300 328

- The DALI controllers RFDALI-04B-SL and RFDALI-32B-SL are designed to control devices with a DALI interface, such as dimmers, electronic ballasts, LED converters and more.
- The control is performed by components from the iNELS Wireless system, detectors, controllers or system devices.
- Assignment and configuration of DALI devices is performed via webserver.
- The DALI bus is powered by the DALI controller.
- Control input "S" for connecting and controlling external buttons.
- The PROG button on the transmitter also serves as a manual output control.
- The repeater function of the components can be set via webserver.
- Range up to 200 m (outdoors), in case of insufficient signal between the controller and the device, use the RFRP-20N signal repeater or components with the RFIO2 protocol that support this function.
- The BOX version offers mounting directly in the installation box, ceiling or luminaire cover, screwless terminals for connection.

Device description

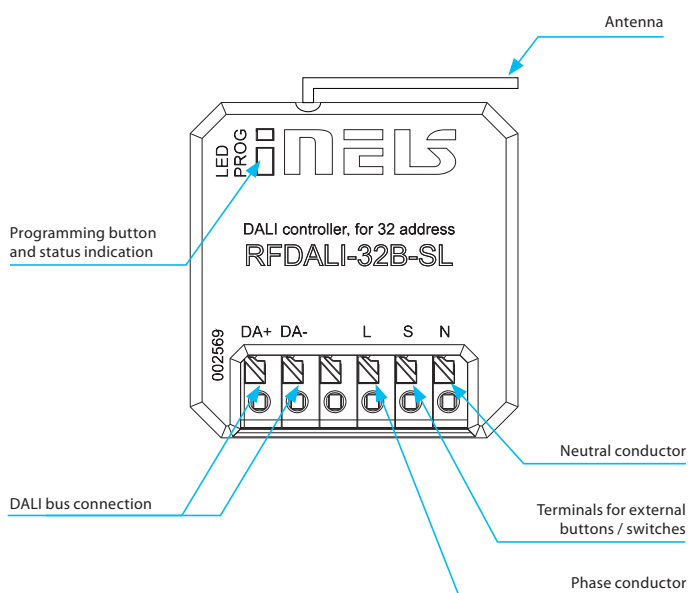

Connection

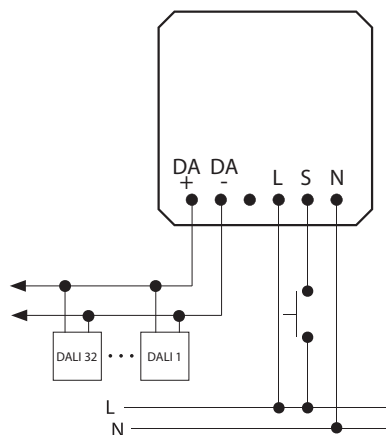



EAN code:
RFDEL-71M: 8595188148979

Technical parameters	RFDEL-71M/230V	RFDEL-71M/120V
Supply voltage:	230 V AC	120 V AC
Supply voltage frequency:	50 Hz	60 Hz
Apparent power:	2.5 VA	1.1 VA
Dissipated power:	0.8 W	0.6 W
Supply voltage tolerance:	+10/-15 %	
Output		
Dimmed load:	R,L,C, LED, ESL	
Contactless:	2 x MOSFET	
Load capacity*:	max. 600 W	max. 300 W*
Control		
Wireless:	up to 32 channels (buttons)	
Communication protocol:	RFIO2	
Frequency:	866–922 MHz (for more information see p. 85)	
Repeater function:	yes	
Range:	in open space up to 160 m	
Manual control:	SW (ON/OFF) button	
External button:	max. 50 m cable	
Glow lamps connection:	no	
Analog control:	potentiometer or 0 (1)–10 V	
Wireless Antenna:	AN-I included (SMA connector**)	
Other data		
Operating temperature:	-20 to +35 °C	
Storage temperature:	-30 to +70 °C	
Operating position:	vertical	
Mounting:	DIN rail EN 60715	
Protection:	IP20 under normal conditions	
Overvoltage category:	II.	
Contamination degree:	2	
Cross-section of connecting wires:	max. 1x 2.5, max. 2x 1.5/with a hollow max. 1x 2.5	
Dimensions:	90 x 52 x 65 mm	
Weight:	125 g	
Related standards:	EN 60730, EN 63044, EN 300 220, EN 301 489	

- The universal modular dimmer is used to regulate light sources:
 - R – classic lamps (resistive load)
 - L – halogen lamps with wound transformer (inductive load)
 - C – halogen lamps with electronic transformer (capacity load)
 - ESL – dimmable energy-efficient fluorescent lamps
 - LED – LED light sources equipped with LED.
- Control can be performed by:
 - detectors, Controllers and System units iNELS Wireless
 - by control signal 0(1)–10 V
 - potentiometer
 - existing button in the installation.
- 6 light functions – smooth increase or decrease with time setting 2 s–30 min. Function description can be found on p. 86.
- Thanks to setting the min. brightness by potentiometer, you will eliminate flashing of the LED and ESL light sources.
- The universal dimmer may be controlled by up to 32-channels.
- The programming button on the controller is also used for manual control of the output.
- The package includes an internal antenna AN-I, in case of locating the unit in a metal switchboard, you can use the external antenna AN-E for better signal reception, see accessories on p. 76.
- Memory status can be pre-set in the event of a power failure.
- Range up to 160 m (in open space), if the signal is insufficient between the controller and unit, use the signal repeater RFRP-20N or protocol component RFIO2 that support this feature.
- The unit's 3-MODULE design with switchboard mounting.

Device description

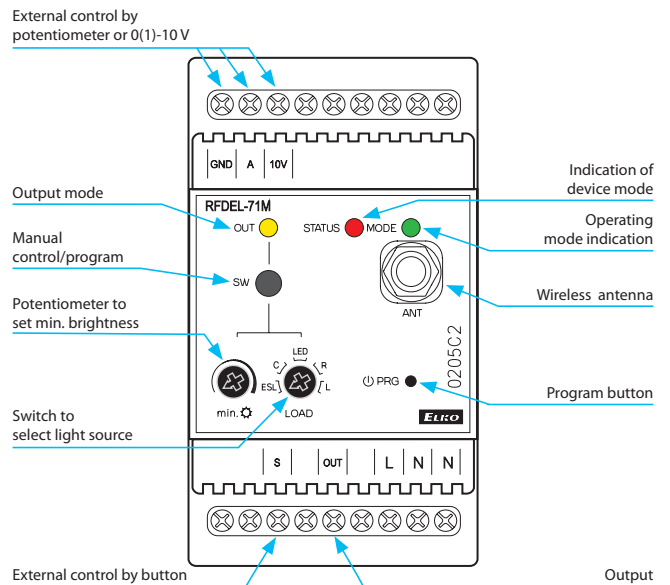

Connection and external control options

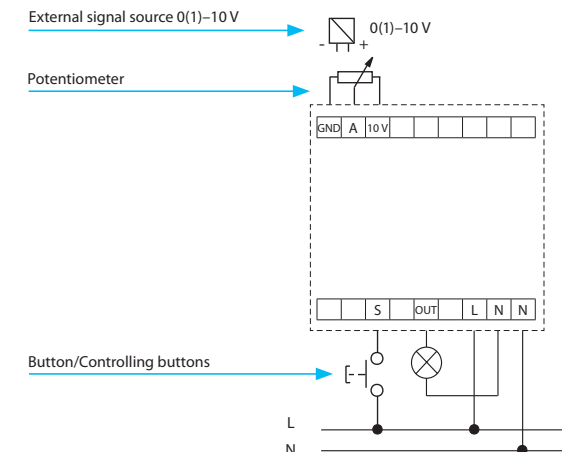

* See page 83 for the load chart for each light source.

** Max. Tightening Torque for antenna connector is 0.56 Nm.



EAN code:

RFDEL-76M/230V: 8595188182058
RFDEL-76M/120V: 8595188182096

Technical parameters RFDEL-76M/230V RFDEL-76M/120V

Supply voltage:	230 V AC	120 V AC
Supply voltage frequency:	50 Hz	60 Hz
Power supply indication:	green LED Un	
Supply voltage tolerance:	+10/-15 %	

Output

Output:	12x MOSFET transistor	
Load type*:	R - resistive, L - inductive, C - capacitive, ESL - economical, LED	
Minimum output power:	10 VA	
Max. output power/channel:	150 VA	75 VA
Possible to connect outputs:	yes	
Maximum power when connecting all outputs:	max. 900 VA	max. 450 VA
Output protection:	thermal/short-term overload/longterm overload/short circuit	

Output indication:	red LED STATUS	
--------------------	----------------	--

Control





Input for buttons:	potential "L" or external voltage AC 20–230 V (50–60 Hz)/DC 20–230 V
Wireless	up to 32-channels (with iNELS Wireless controllers)
Communication protocol:	RFIO2
Function repeater:	yes
Range:	in the open up to 160 m (524.11 ft)
Wireless antenna:	AN-I included (SMA connector)

Other information

Operating temperature:	-20 to +50 °C (-4 to 122 °F)
Storage temperature:	-30 to +70 °C (-22 to 158 °F)
Ingress protection:	IP20 under normal conditions
Overvoltage category:	II.
Contamination degree:	2
Connecting conductor:	max. 2.5 mm ² /1.5 mm ² with sleeve
Operating position:	vertical
Installation:	in the switchboard on DIN rail EN 60715
Design:	6-MODULE
Dimensions:	90 x 105 x 65 mm (3.5" x 4.1" x 2.6")
Weight:	320 g (11 oz.)
Related standards:	EN 60730, EN 63044, EN 301489, EN 300 220

*Warning: it is not allowed to simultaneously connect loads of inductive and capacitive type in the same channel.

Types of connectable loads

 HAL 230 V	 HAL 12-24 V			
R resistive	L inductive	C capacitive	LED light	ESL saving

- RFDEL-76M is a universal 6-channels actuator, which is used to control the brightness intensity of dimmable sources R - L - C - LED - ESL.
- The maximum possible load is 150 VA for 230 V and 75 VA for 120 V for each channel.
- The individual channels of the dimmer can be connected in parallel and thus increase the maximum output load at the expense of the number of outputs.
- Each of the output channels is individually controllable and addressable.
- By setting the min. brightness eliminates flickering of different types of light sources, setting min. brightness and type of load is done using the PROG buttons.
- Electronic overcurrent, thermal and short-circuit protection, which switches off the output.
- 6 galvanically isolated inputs for wired buttons, which can be used to control the outputs independently of the iNELS Wireless.
- The package includes an internal AN-I antenna, in case of placement of a sheet metal distribution element, you can use an external AN-E antenna to improve the signal.

Description

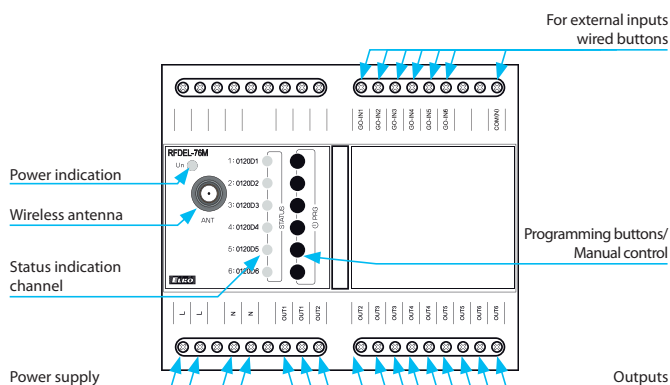

Connection

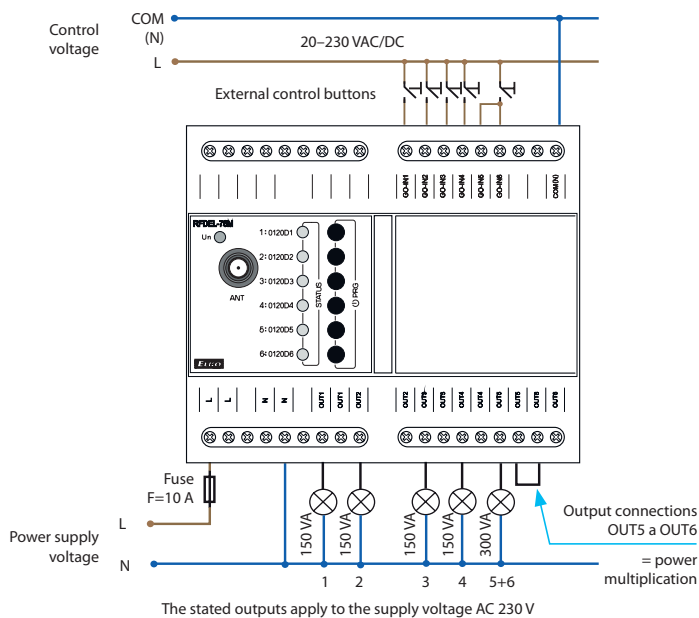

Power supply voltage

The stated outputs apply to the supply voltage AC 230 V



EAN code:
RFDA-73M/RGB: 8595188146814

Technical parameters	RFDA-73M/RGB
Supply terminals:	Un+, GND
Supply voltage:	12–24 V DC stabilized
Maximum power without load:	0.8 W
Output	
Dimmed load:	LED strip 12 V, 24 V with common anode RGB LED strips 12 V, 24 V with common anode
Number of channels:	3
Rated current:	3x5 A
Peak current:	3x10 A
Switching voltage:	Un
Control	
Wireless:	up to 32-channels (buttons)
Communication protocol:	RFIO2
Frequency:	866–922 MHz (for more information see p. 85)
Repeater function:	yes
Load capacity of output +10 V:	10 mA
Ext. signal:	0–10 V, 1–10 V
Range:	in open space up to 160 m
Wireless Antenna:	AN-I included (SMA connector*)
Other data	
Operating temperature:	-20 to +50 °C
Storage temperature:	-30 to +70 °C
Working position:	any
Mounting:	DIN rail EN 60715
Protection:	IP20 from front panel
Contamination degree:	2
Cross-section of connecting wires (mm ²):	max. 1x 2.5, max. 2x 1.5/ with a hollow max. 1x 2.5
Dimensions:	90 x 52 x 65 mm
Weight:	130 g
Related standards:	EN 60730, EN 63044, EN 300 220, EN 301 489

* Max Tightening Torque for antenna connector is 0.56 Nm.

- The dimmer for LED strips is used for independent control of 3 single-colour LED strips or one RGB LED strip.
- The expanded selection of control modes enables it to be combined with:
 - a) detectors, controllers and system units iNELS Wireless
 - b) device with output signal 0 (1)–10 V
 - c) potentiometer.
- The unit's 3-MODULE design with switchboard mounting enables connection of dimmed load 3x 5 A, which represents:
 - a) single-colour LED strip 7.2 W – 3x 8 m
 - b) RGB LED strip 14.2 W–10 m.
- 6 light functions – smooth increase or decrease with time setting 2 s – 30 min. Function description can be found on p. 86.
- The dimmer may be controlled by up to 32-channels.
- The power supply of the unit is in the range of 12–24 V DC, and is indicated by a green LED.
- The package includes an internal antenna AN-I, in case of locating the unit in a metal switchboard, you can use the external antenna AN-E for better signal reception, see accessories on p. 76.
- Memory status can be pre-set in the event of a power failure.
- Range up to 160 m (in open space), if the signal is insufficient between the controller and unit, use the signal repeater RFRP-20N or protocol component RFIO2 that support this feature.

Device description

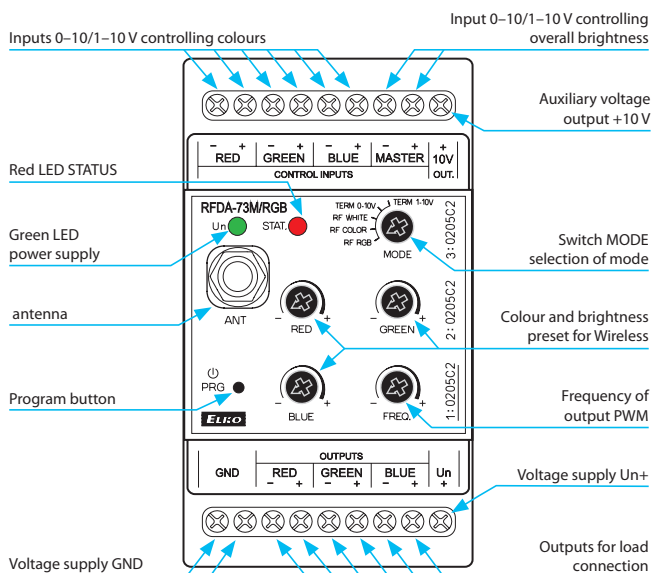

Output variations and external control options

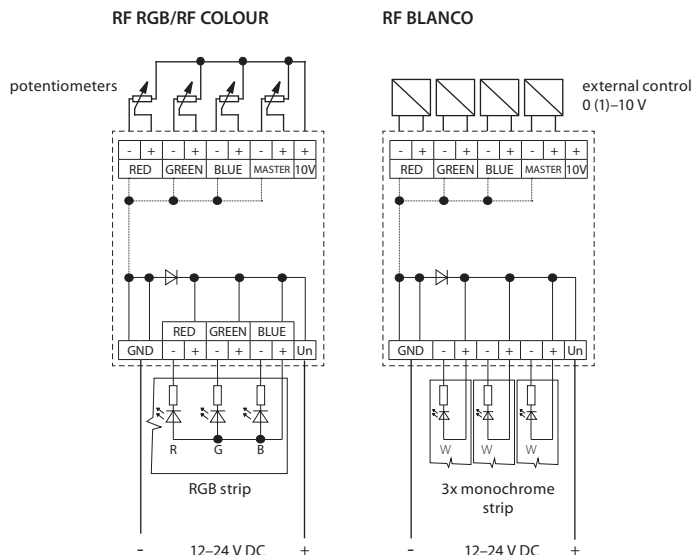

Control modes

RF RGB
Switch settings in MODE:

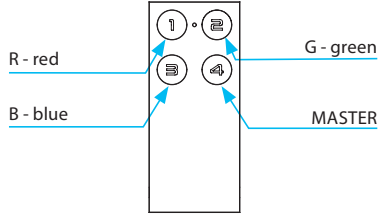
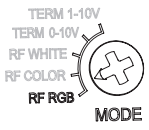

RF RGB mode for controlling RGB LED strips. In the RF RGB programming mode, colours are automatically assigned to individual transmitter buttons.

Note: The mode can be controlled by RF Touch, RF Pilot, RFWB-40/G, RF KEY, and eLAN-RF.

RF Color
Switch settings in MODE:

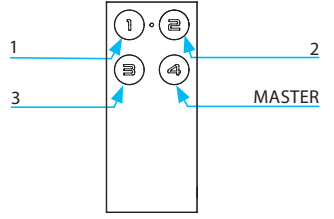
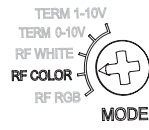

RF COLOUR mode for controlling RGB LED strips, where you can choose the colour for individual transmitter buttons. A long press of the button starts the colour search mode. After releasing the button, the current colour is set for the given button.

Note: The mode can be controlled by RF Touch, RF Pilot, RFWB-40/G, RF KEY, and eLAN-RF.

RF BLANCO
Switch settings in MODE:

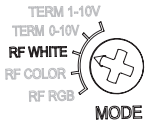

This works in a mode where it acts like three independent dimmers for 12–24 V. Each channel can be programmed independently of one another and has its own address.

Note: The mode can be controlled by RF Touch, RF Pilot, RFWB-20/G, RFWB-40/G, RF KEY and eLAN-RF.

TERM 0–10 V and TERM 1–10 V
Switch settings in MODE:

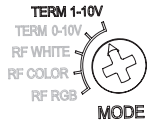
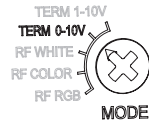

Modes TERM 0–10 V and TERM 1–10 V. Inputs 0–10 V and 1–10 V used to control one RGB LED strip or three independent single-colour LED strips (see modes above) from the iNELS BUS System. For controlling, you can use the application iHC for smartphones and tablets.

Control options

TERM 0(1)–10 V DC
- monochrome LED strips

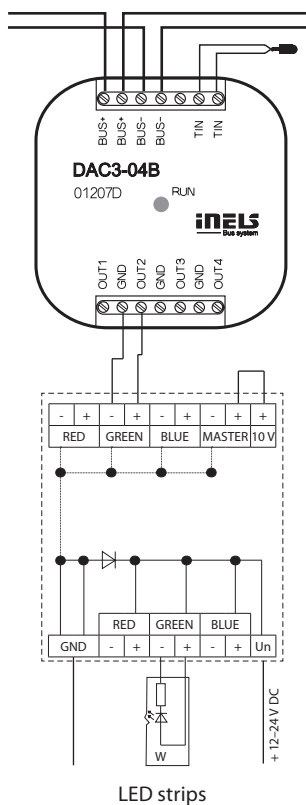

TERM 0(1)–10 V DC
- RGB LED strips

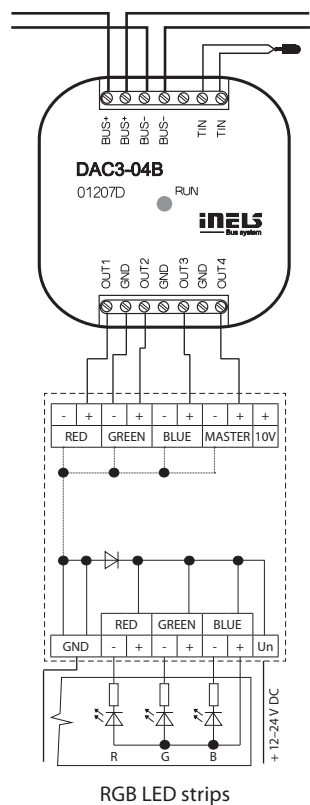



EAN code:
 RFDSC-71N/Schuko: 8595188183604 RFDSC-71N/British: 8595188183581
 RFDSC-71N/French: 8595188183598

Technical parameters		RFDSC-71N/230V
Supply voltage:		230 V
Supply voltage frequency:		50-60 Hz
Apparent power:		1.1 VA
Dissipated power:		0.8 W
Supply voltage tolerance:		+10/-15 %
Output		
Contactless:		2 x MOSFET
Load capacity:*		max. 200 W
Dimming load:		R, L, C, LED, ESL
Control		
Wireless:		up to 32-channels (buttons)
Communication protocol:		RFIO2
Frequency:		866-922 MHz (for more information see p. 85)
Repeater function:		no
Range:		in open space up to 160 m
Manual control:		button PROG (ON/OFF)
Other data		
Operating temperature:		-20 to + 35 °C
Storage temperature:		-30 to +70°C
Working position:		any
Mounting:		plug into a socket
Protection:		IP30
Overvoltage category:		III.
Contamination degree:		2
Dimensions:		63 x 110 x 74 mm
Weight:		118 g
Related standards:		EN 60730, EN63044, EN 300 220, EN 301 489

- The dimmable socket is used to regulate the brightness of the luminaires, which are connected by a power cord with a plug:
 - R - classic light bulbs (resistive load)
 - L - halogen bulbs with wound transformer (inductive load)
 - C - halogen bulbs with electronic transformer (capacitive load)
 - ESL - dimmable energy saving lamps
 - LED - light sources equipped with LED
- Multifunction - 6 light functions - smooth start or stop with time setting 2 s - 30 min. Description of functions on p. 86.
- Min. brightness potentiometer eliminates flickering of LED and ESL light sources.
- The universal dimmer can be controlled by up to 32 channels.
- The programming button on the socket also serves as a manual output control.
- Possibility to set the output status memory in case of failure and subsequent power recovery.
- Range up to 160 m (outdoors), in case of insufficient signal between the controller and the device, use the RFRP-20N signal repeater or components with the RFIO2 protocol that support this function.



Device description

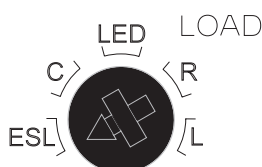
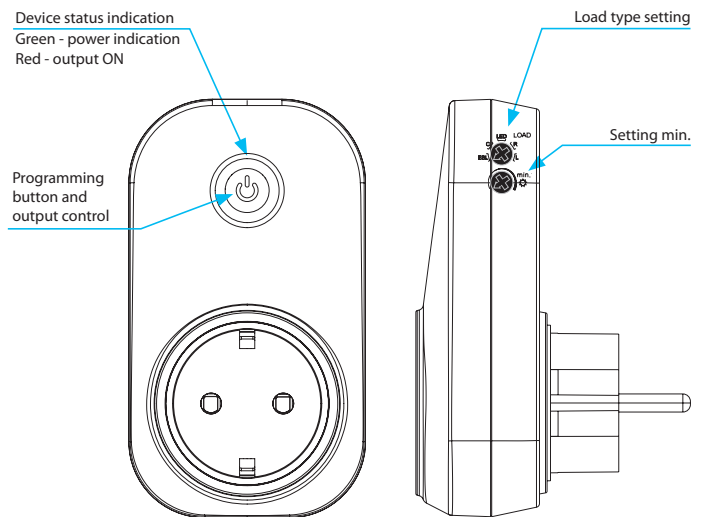

Types of loads	
ESL	dimmable energy saving lamps
C	halogen bulbs with electronic transformer (capacitive load)
LED	LED light sources
R	classic light bulbs (resistive load)
L	halogen bulbs with wound transformer (inductive load)



The picture of device is illustrative, the icons (symbols) are configurable by the customer.



- Designed to control 2 and 4 pipe fan coils, chillers
- 3x relays for fan speed (LOW, MEDIUM, High), 2x relays for heating/cooling mode
- 2x analog outputs 0-10V for proportional control of valves
- 2x inputs for connecting wired detectors (magnet doors/windows); of which 1 input can
- Built-in digital temperature and humidity sensor
- Proximity sensor to activate display backlight / buttons
- VA/TN LCD display, 8 touch backlit buttons
- Screwless angle clamps for easy wire connection
- WiFi for thermostat setup (via web browser) and connection to iNELS Cloud, iNELS APP and MRS via MQTT protocol
- Modbus RTU for external HVAC devices and higher-level systems
- Power supply: AC 110 – 230V AC
- Black or white finish
- Box for mounting on EU/BS installation boxes
- Possibility of custom tuning and design modifications (button functions, icon options, logos): icons.inels.co

Technical parameters	RFTC-3/W	RFTC-3/B	
Power supply			
Power supply voltage:	110 - 230V AC, 50-60Hz, L and N terminals		
Apparent/loss power input:	4 VA/2 W		
Supply voltage tolerance:	± 10%		
Outputs			
Relays:	5x switching / 5A / 250V AC1 / 1385VA		
Contact life:	mechanical: 10 mil. / electrical 100.000 switches		
Analog Output:	2x 0-10V, 10 mA		
Inputs (external)			
Binary:	1x potential-free contact, terminals IN1/IN2 against GND, maximum wire length 30m		
Temperature:	1x for external temperature sensor TC/TZ, terminals IN1/T & IN2/TC, temperature range -20 to +120 °C, accuracy ± 0.5 °C		
Sensors (internal)			
Temperature:	range 0 to +55 °C, accuracy ± 0.5 °C from the range		
Humidity:	0 - 99% RH, accuracy ± 3 °C from the range		
Proximity:	backlight activation when zooming <25 cm		
Lighting:	adaptive backlight control of the display and buttons		
Communications			
Radio:	iNELS RFIO2, frequency 866-922 Mhz		
WiFi:	AP 2.4 Ghz		
Modbus:	RTU 485		
Control and display			
Display:	LCD (VA/TN), active area 54x34mm		
Buttons:	8x, capacitive, backlit		
Functions			
Fancoil types:	2-pipe, 4-pipe		
Parameter settings:	via WiFi and web interface		
Connection			
Terminal block:	16 pole, screwless (push-in)		
Wire cross section:	0.2 - 1.5 mm ² solid / flexible		
Mechanics			
Operating temperature:	- 0 to 50 °C / max 80% RH		
Storage Temperature:	- 20 to 60 °C		
Enclosure:	IP30 (mounted)		
Overvoltage Category:	II.		
Pollution Degree:	2		
Working position:	horizontal		
Installation:	on EU or British box with 60 mm bolt spacing		
Dimension:	120x80x27 mm		
Weight:	219 g		
Shape:	sharp edges		
Color (glass and plastic):	White	Black	
Order Code:	8915	8914	
EAN Code:	8595188189156	8595188189149	
Standard:	EN 60730	EN 63044	EN 301489

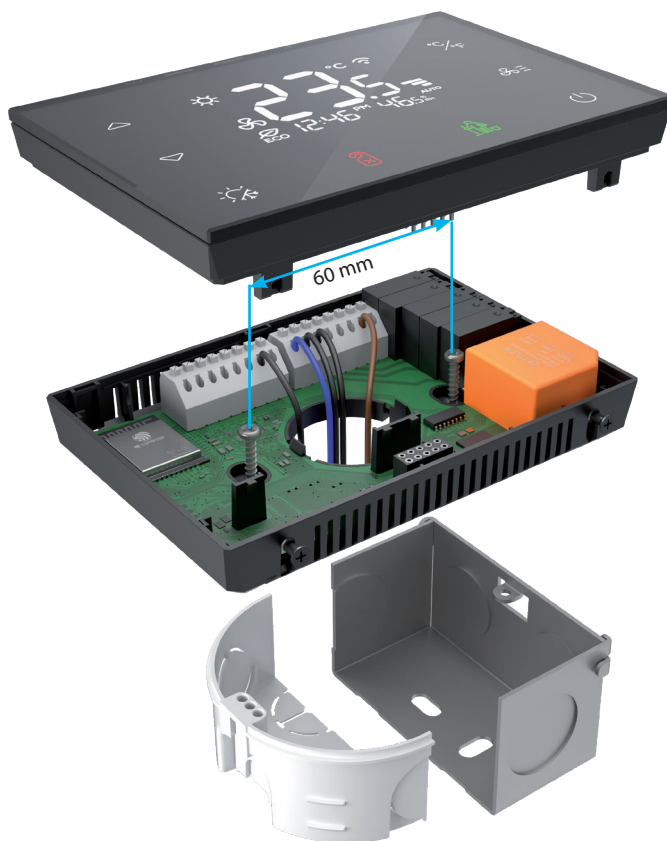

External temperature sensors:

	TC-0	TC-3	TC-6	TC-12
Length:	100 mm	3 m	6 m	12 m
Order code:	209970800010	209970800011	209970800012	209970800013



Buttons and display description

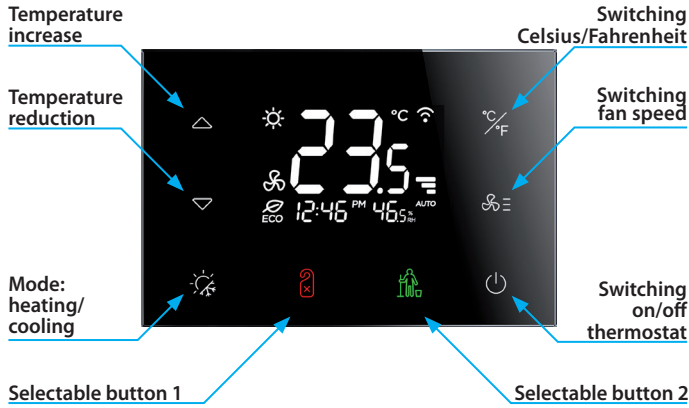

Display description

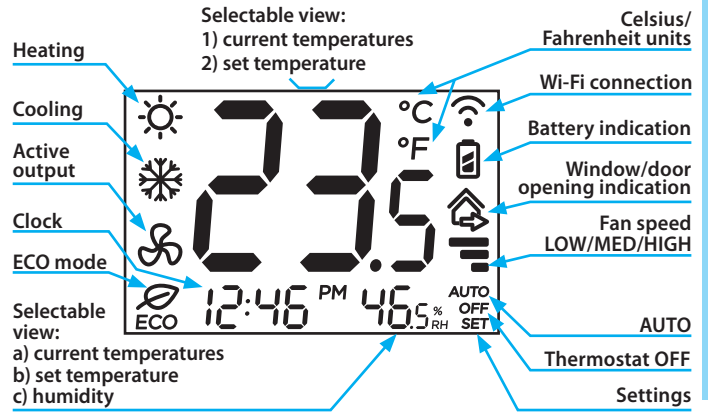

Connection

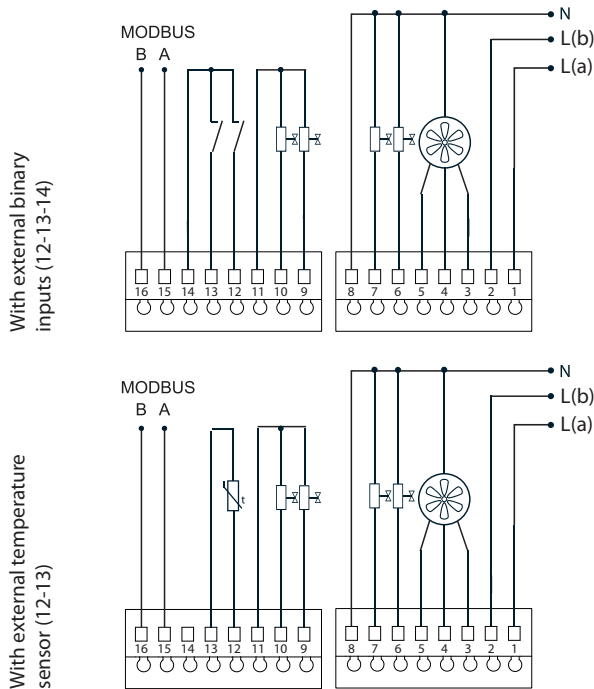

Web configuration

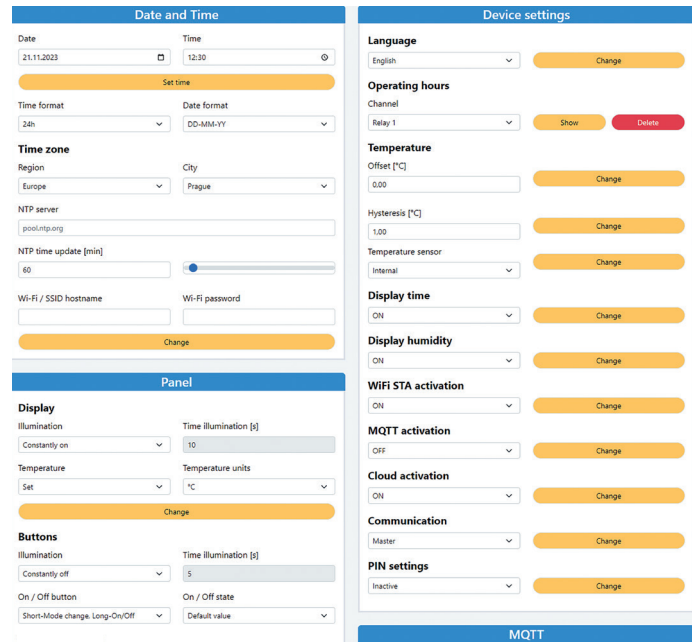

Clamp description

- 1. L(a) power supply phase wire
- 2. L(b) phase - identical to phase L(a) - see.*
- 3. HIGH fan top speed
- 4. MED fan medium speed
- 5. LOW fan lowest speed
- 6. HEAT valve 0/1 for heating
- 7. COOL valve 0/1 for cooling
- 8. N neutral wire power supply
- 9. 1:0-10V 1. analog output 0-10V
- 10. 2:0-10V 2. analog output 0-10V
- 11. GND common terminal for analog output
- 12. IN1 1. binary input for external contact
- 13. IN2 2. binary input for external contact
- 14. COM common terminal for binary inputs 1. and 2.
- 15. BUS A Modbus A
- 16. BUS B Modbus B

Option for an external temperature sensor TC/TZ

- 12. IN1 temperature input NTC
- 13. IN2 temperature input NTC

* in the case of an auxiliary heater, it is connected to terminals 6 or 7 (max. 1500 W).

Variants



RFTC-3/B
Order code: 8914

RFTC-3/W
Order code: 8915



Icons are illustrative, the actual appearance is configurable using the configurator.

- Designed to control RFSTI-11B, RFSA-266M
- Built-in digital temperature and humidity sensor
- VA/TN LCD display, 8 touch backlight buttons
- WiFi for parameter setting (via web browser and for connection to iNELS.Cloud, iNELS APP only with external power supply)
- iNELS RFIO2 for wireless communication with iNELS Wireless units
- Power supply: 2x AA 1.5 V or USB-C 5 V
- Black or white glass design
- Box for mounting on EU/BS installation boxes with 60 mm screw spacing
- 6 thermostat buttons, 2 buttons options for control switch units, dimmers or switch units for blinds from iNELS Wireless portfolio
- Possibility of custom tuning and design modifications (button functions, icon options, logos): icons.inels.com

Technical parameters	RFTC-4/W	RFTC-4/B
Power supply		
Power supply voltage:	2x AA 1.5 V or USB-C 5 V	
Sensors (internal)		
Temperature:	range 0 to +55 °C, accuracy ± 0.5 °C from the range	
Humidity:	0 - 99% RH, accuracy ± 3% from the range	
Communications		
Radio:	iNELS RFIO2, frequency 866-922 Mhz	
Wifi:	2.4 GHz only with external power supply	
Control and display		
Display:	LCD (VA/TN), active area 54x34mm	
Buttons:	8x, capacitive, backlit, configurable	
Other data		
Operating temperature:	- 0 to 50 °C / max 80% RH	
Storage Temperature:	- 20 to 60 °C	
Enclosure:	IP30 (mounted)	
Overvoltage Category:	II.	
Pollution Degree:	2	
Working position:	horizontal	
Installation:	on EU or British box with 60 mm bolt spacing, desk stand	
Dimension:	120x80x27 mm	
Weight:	218 g	
Shape:	sharp edges	
Color (glass and plastic):	White	Black
Order Code:	8917	8916
EAN Code:	8595188189170	8595188189163
Standard:	EN 60730, EN 63044, EN 301489, EN 300220	

Web configuration

An external USB-C power supply must be connected for initial setup. After that, configuration can be done via own Wifi and web interface. Wi-Fi SSID: RFTC-4_product number IP address: 192.168.1.1

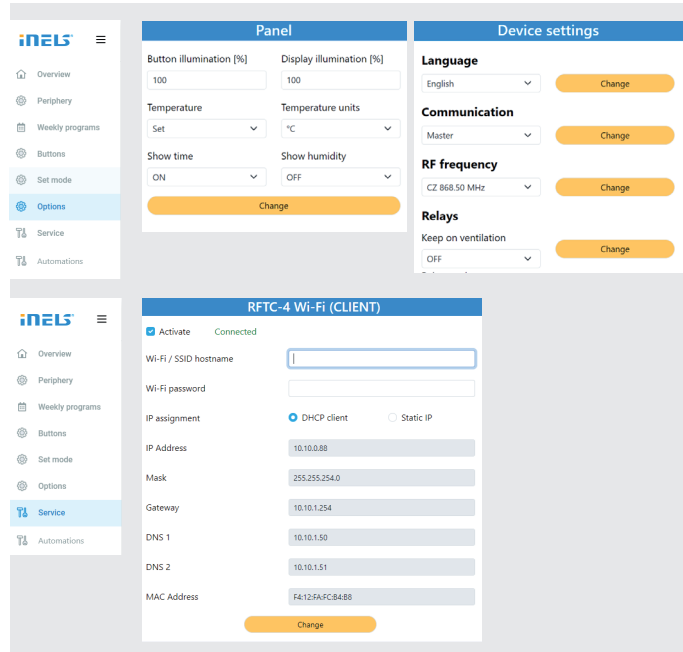

Icons are illustrative - configure your own look using the configurator: icons.inels.com

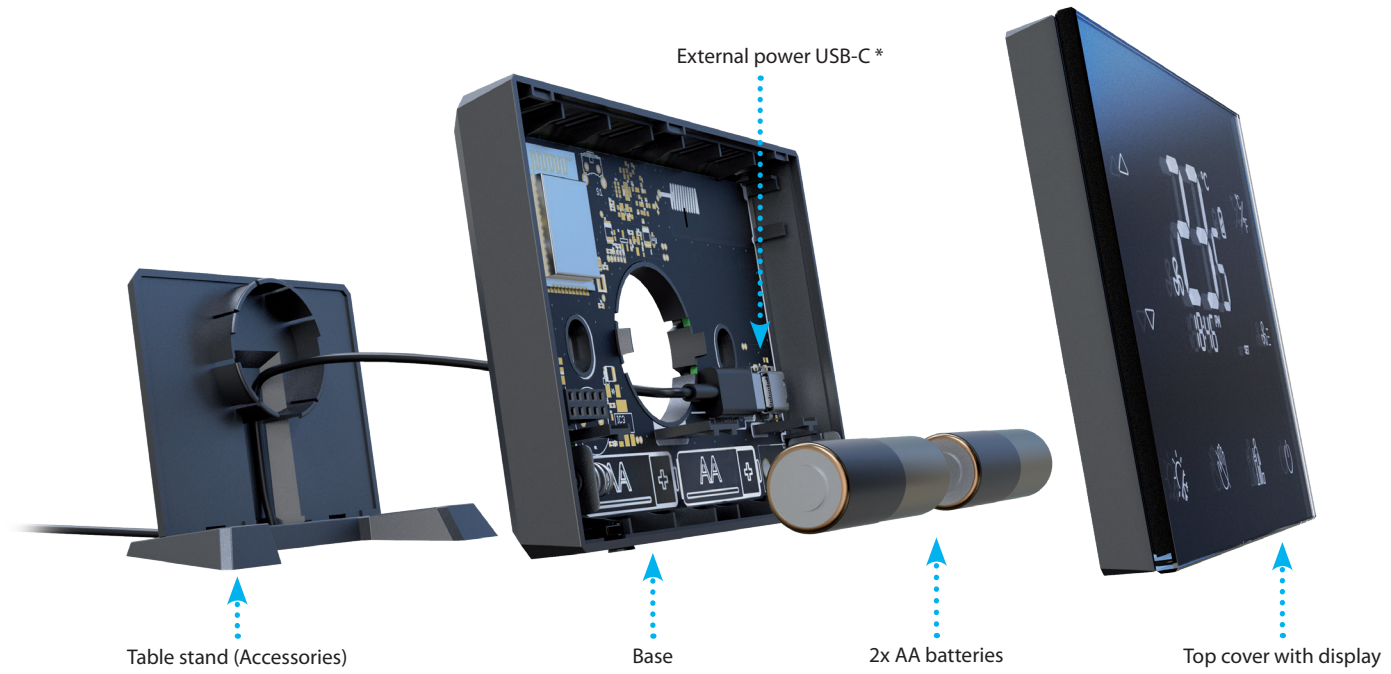

Buttons and display description

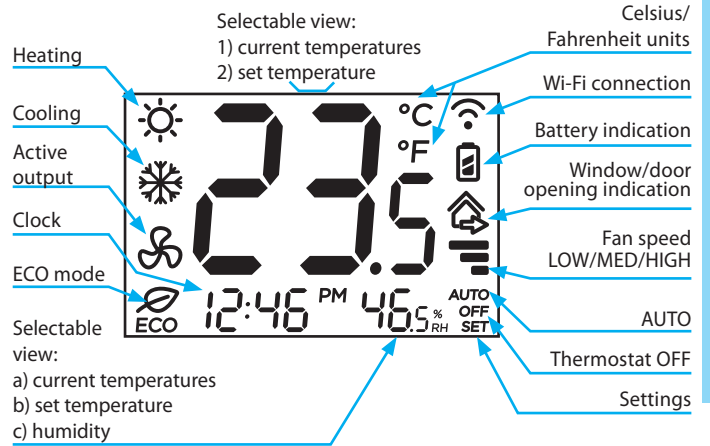
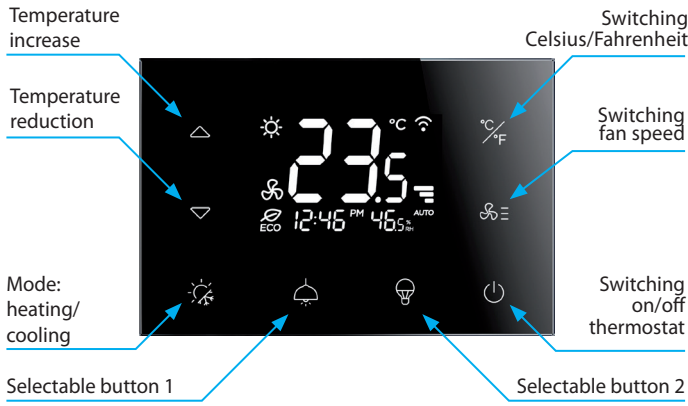

* External adapter can be used in case of permanent backlight or connection to iNELS.Cloud or app.

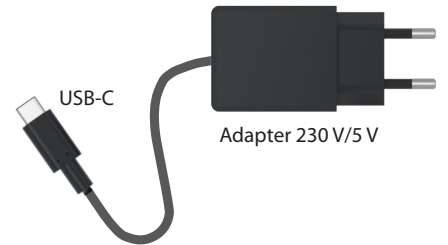

RFSTI-11B/SL
Switch unit with external temperature sensor

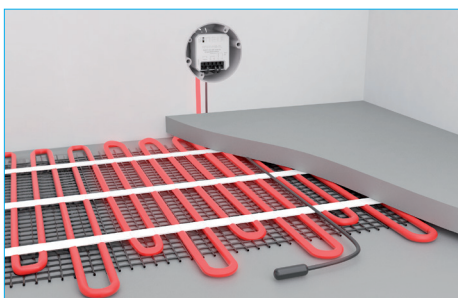

RFSA-266M
Switch unit for fancoil control
· If RFSA-266M is connected, it can be configured via web interface





EAN code:
RFTC-10/G: 8595188145329

Technical parameters	RFTC-10/G
Supply voltage:	2 x 1.5 V AAA batteries
Battery life:	1 year based on frequency of use
Temperature correction:	2 buttons √/∧
Temperature offset:	± 5 °C
Display:	LCD, characters/see Display description
Backlighting:	active 10 s after pressing
Transmission indication/function:	symbols
Temperature measurement:	1x internal sensor
Temp. measurement range and accuracy:	0 to +55 °C; 0.3 °C of the range

Control	
Communication protocol:	RFIO
Frequency:	866–922 MHz (for more information see p. 85)
Repeater function:	no
Signal transmission method:	bidirectionally addressed message
Range:	in open space up to 100 m
Minimum control distance:	20 mm

Other data	
Max. number of control.	
RFSA-6x:	1
Program:	x
Operating temperature:	0 to +55 °C
Operating position:	wall-mounted
Mounting:	glue/screws
Protection:	IP30
Contamination degree:	2
Dimensions frame	
- plastic:	85 x 85 x 20 mm
- metal, glass, wood, granite:	94 x 94 x 20 mm
Weight:	66 g (without batteries)
Related standards:	EN 60730, EN 63044, EN 300 220, EN 301 489

Compatibility				
RF Touch	eLAN-RF	RFSAI-6x/RFSAI-6x	RFSTI-11B-SL	RFATV-2
✓	✓	✓	-	-

Display description

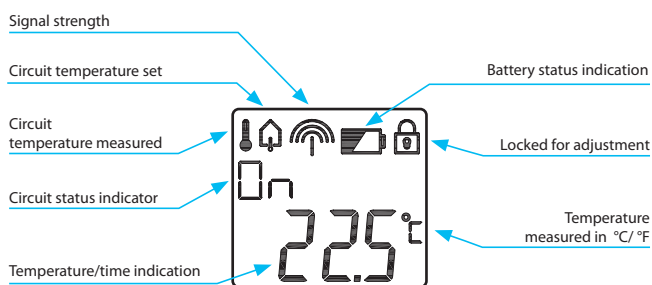

- RFTC-10/G is used for temperature measurement (in the range of 0 to 55 °C) and correction of the pre-set temperature in RF Touch or eLAN-Wireless system devices in the range of ± 5 °C. The temperature correction is valid until the next program change in the given system device.
- The backlit LCD display displays the current and set temperature, status (ON/OFF), battery status, etc.
- Range up to 100 m (in open space), if the signal is insufficient between the controller and unit, use the signal repeater RFRP-20N or protocol component RFIO2 that support this feature.
- Colour combination of heating unit in design of frames LOGUS⁹⁰ (plastic, glass, wood, metal, stone).

Device description

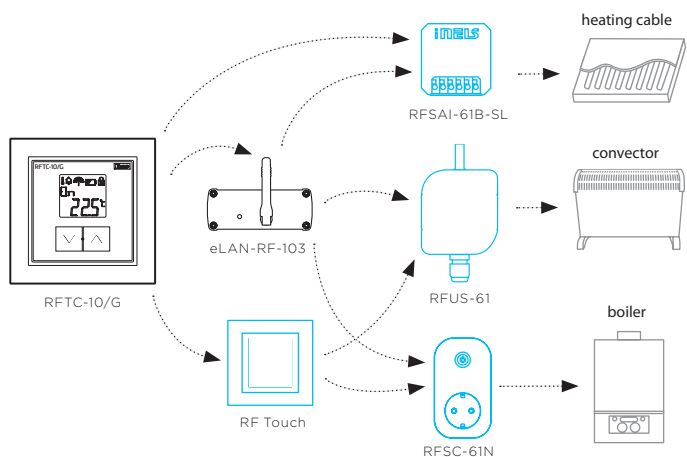
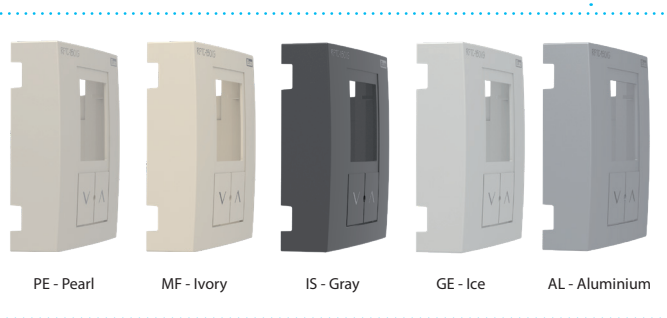
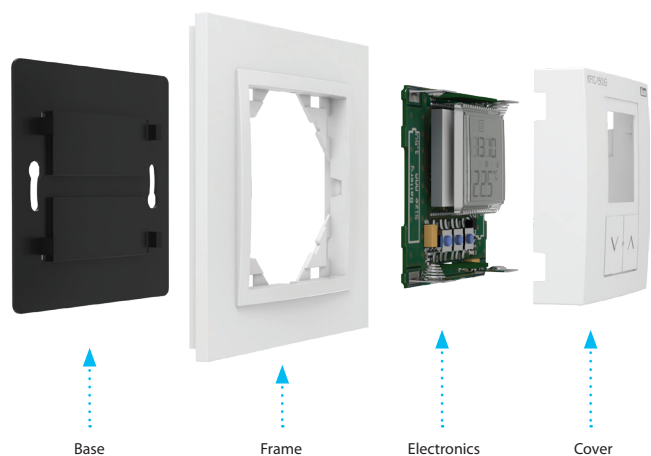



EAN code:
RFTC-50/G: 8595188148641

Technical parameters		RFTC-50/G
Supply voltage:	2x 1.5 V AAA batteries	
Battery life:	1 year based on frequency of use according to the number of controlling actuators	
Temperature correction:	2 buttons V / ^	
Temperature offset:	± 5 °C	
Display:	LCD, characters/see Display description	
Backlighting:	active 10 s after pressing	
Transmission indication/function:	symbols	
Temperature measurement:	1x internal sensor	
Temp. measurement range and accuracy:	0 to +55 °C; 0.3 °C of the range	
Control		
Communication protocol:	RFIO	
Frequency:	866–922 MHz (for more information see p. 85)	
Repeater function:	no	
Signal transmission method:	bidirectionally addressed message	
Range:	in open space up to 100 m	
Minimum control distance:	20 mm	
Other data		
Max. number of control.	4	
RFSA-6x:	4	
Program:	Weekly	
Operating temperature:	0 to + 55 °C	
Operating position:	on the wall	
Mounting:	by gluing/screwing	
Protection:	IP30	
Contamination degree:	2	
Dimensions frame		
- plastic:	85 x 85 x 20 mm	
- metal, glass, wood, granite:	94 x 94 x 20 mm	
Weight:	66 g (without batteries)	
Related standards:	EN 60730, EN 63044, EN 300 220, EN 301 489	

Compatibility				
RF Touch	eLAN-RF	RFSA-6x/RFSAI-6x	RFSTI-11B-SL	RFATV-2
-	-	✓	✓	-

Display description

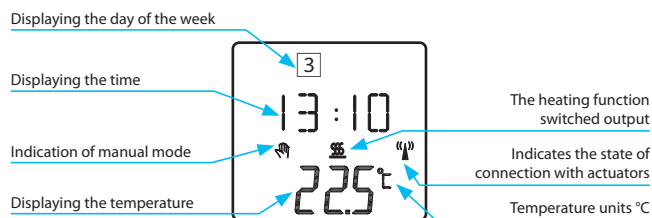

- RFTC-50/G is a separate thermostat that allows wireless control of up to 4 multifunctional switching components, e.g. RFSAI-6x, RFUS-61, RFSTI-11B.
- Temperature measurement with built-in sensor in the range of 0.55 °C, temperature setting in the range of 0 to +55 °C in the weekly program.
- The backlit LCD display displays the current and set temperature, status (ON/OFF), battery status, day of the week, current time, etc.
- Battery power (2x 1.5 V AAA batteries - included in supply) with battery life of around 1 year based on frequency of use.
- Range up to 100 m (in open space), if the signal is insufficient between the controller and unit, use the signal repeater RFRP-20N or protocol component RFIO2 that support this feature.
- Colour combination of temperature unit in design of frames LOGUS⁹⁰ (plastic, glass, wood, metal, stone).

Device description

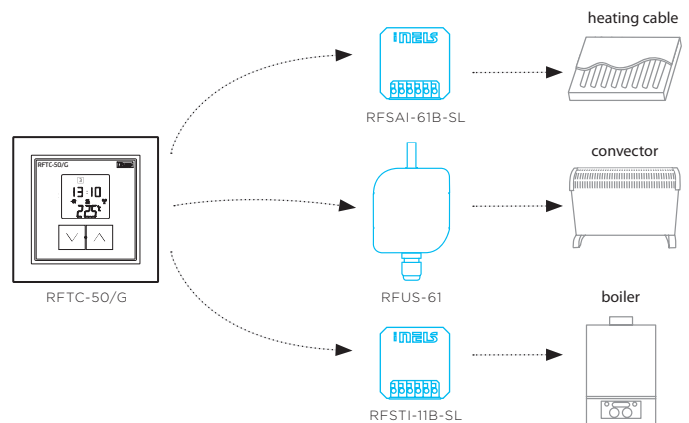
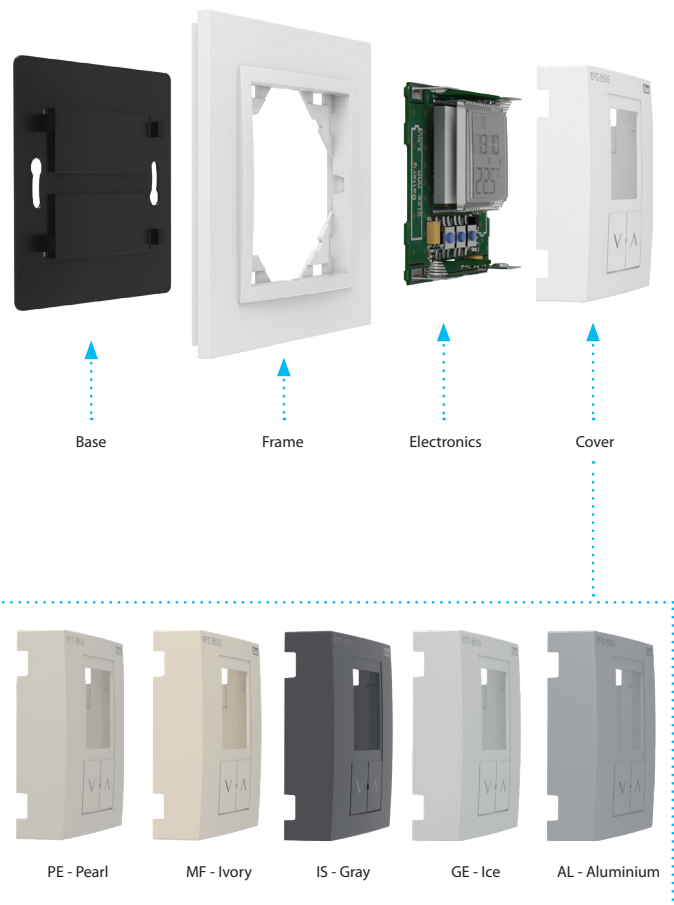

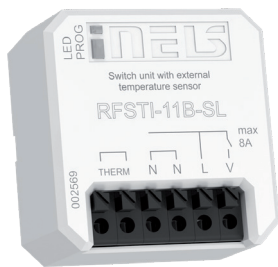

EAN code:
RFSTI-11B-SL: 8595188184045

Technical parameters	RFSTI-11B-SL
Supply voltage:	230 V AC
Supply voltage frequency:	50-60 Hz
Apparent input:	7 VA / $\cos \varphi = 0.1$
Dissipated power:	0.7 W
Supply voltage tolerance:	+10 %; -15 %
Temp. measurement range and accuracy:	-20 to +50 °C 0.5 °C of the range
Output	
Number of contacts:	1x switching
Rated current:	8 A / AC1
Switching power:	2000 VA / AC1
Peak current:	10 A / <3 s
Switching voltage:	250 V AC1
Mechanical service life:	1x10 ⁷
Electrical service life (AC1):	1x10 ⁵
Control	
Wireless:	25-channels
Communication protocol:	RFIO2
Frequency:	866-922 MHz (for more information see p. 85)
Repeater function:	yes
Manual control:	button PROG (ON/OFF)
External button/switch:	yes
Range:	in open space up to 200 m
Other data	
Operating temperature:	-15 to +50 °C
Operating position:	any
Mounting:	free at lead-in wires
Protection:	IP40
Overvoltage category:	III.
Contamination degree:	2
Connection:	screwless terminals
Connecting conductor:	0.2-1.5 mm ² solid/flexible
Dimensions:	43 x 44 x 22 mm
Weight:	31g
Related standards:	EN 60730, EN 63044, EN 300 220, EN 301 489

- The temperature element measures the temperature with an external sensor and at the same time controls the heating circuit (electric under-floor heating, air conditioning, boiler...).
- They can be combined with Detectors, Controllers or iNELS Wireless system components.
- It measures the temperature in the range -20 to +50 °C and sends it to the system component in a regular 5 min. intervals. It sends a signal when the temperature changes suddenly.
- The heating/cooling, hysteresis and offset functions are set in the system component or application.
- It allows the connection of a switched load up to 8 A (2,000 W).
- Range up to 200 m (outdoors), in case of insufficient signal between the controller and the device, use the RFRP-20N signal repeater or component with the RFIO2 protocol that support this function.
- The BOX version offers installation directly in the installation box, ceiling or cover of the controlled appliance. Easy installation thanks to screwless terminals.
- External sensor TC (-20 to +80 °C) or TZ (-40 to +125 °C) with a length of 3 m, 6 m, 12 m. See „Accessories“ on page 45.

Device description

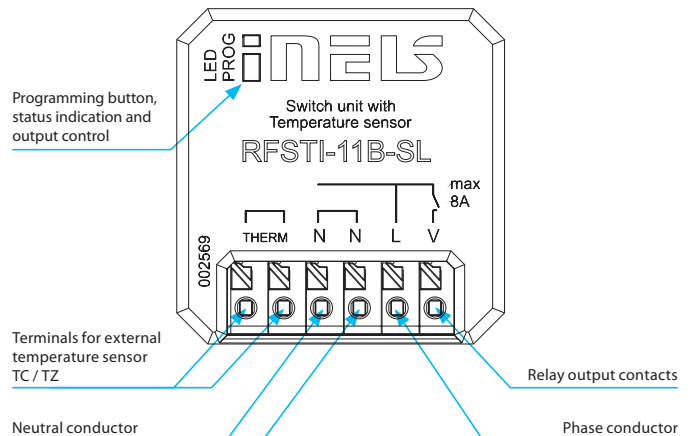

Connection

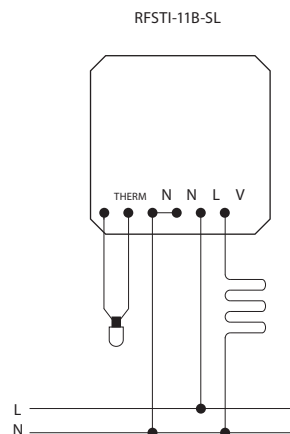



- With an integrated digital sensor, it measures temperature and humidity in the range of -10 to +50 °C and at regular intervals of 20 min. sends it to the system device (eLAN-RF, RF-Touch).
- In the event of a sudden change in temperature and humidity, it sends a signal within 1 min.
- (2x 3 V batteries CR 2032 - included in the package) with a lifetime approx. 1 year (according to ambient temperature cycling).
- Range up to 160m (in open space), in case of insufficient signal between the controller and the device, use RFRP-20N signal repeater or devices with RFIO2 protocol that support this function.

EAN code:
RFTI-20: 8595188134019

Technical parameters		RFTI-20
Supply voltage:	2x 3 V CR 2032 battery	
Battery life:	up to 1 year, according to the number of activations	
Transmission indication/function:	red LED	
Temperature and humidity measurement:	integrated digital sensor	
Temperature measurement range and accuracy:	-10 to +50 °C; 0.5 °C of range	
Humidity measurement range and accuracy:	0 to 90 %; ±3 % of range	
Output		
Communication protocol:	RFIO	
Frequency:	866–922 MHz (see p. 85)	
Repeater function:	no	
Signal transmission:	unidirectional message	
Range:	in open space up to 160 m	
Other data		
Operating temperature:	-10 to +50 °C	
Working position:	any	
Mounting:	glue/screws/loose	
Protection:	IP30	
Contamination degree:	2	
Dimensions:	75 x 25 x 14 mm	
Weight:	45 g	
Related standards:	EN 60730, EN 63044, EN 300 220, EN 301 489	

Device description





EAN code:
RFATV-2: 8595188182591

Technical parameters		RFATV-2
Supply voltage:	2x 1.5 V battery AA	
Battery life:	1 year based of frequency use	
Control		
Communication protocol:	RFIO	
Frequency:	866–922 MHz (for more information see p. 85)	
Wireless command from controller:	eLAN-RF-103, RF Touch 2	
Range:	in open space up to 200 m	
Other data		
Operating temperature:	0 °C to +50 °C	
Operating position:	any	
Protection:	IP40	
Dimension:	52 x 52 x 70 mm	
Thermo-valve nuts:	M 30 x 1.5	
Related standards:	EN 60730	

Accessories (not included)

RE-C Reduction Coterm	
RE-DRTD Reduction Danfoss RTD	
RE-D Reduction Danfoss	
RE-G Reduction Giacomini	
RE-M Reduction Myjava	
RE-H Reduction Herz	

- The wireless thermovalve is used to regulate the temperature in the room. It is installed directly on the radiator valve, where it immediately measures the temperature in the room with the help of an internal temperature sensor and regulates the radiator valve with the built-in motor. The valve can also be installed on valves in distribution boards, when a temperature sensor from another element of the iNELS Wireless system will be used to measure the temperature in the room.
- To use the functions of the valve, it is necessary to connect it to the eLAN-RF or RF Touch system units, which will ensure heating and control of the valve from the app (Android, iOS, Samsung Smart TV) and the system unit with manual or automatic temperature modes.
- The valve measures the temperature in the range of 0°C...50°C and receives control instructions from the system units at a regular interval of every 6 minutes.
- The valve supports functions of anti-freeze mode, open window detection, communication failure with system unit and valve stiffening, which are described in detail below.
- The valve supports hysteresis and offset functions that can be set in the application or system unit.
- Battery power 2x AA 1.5 V batteries (included in the package)
- Communication range with system unit up to 200 m (in open space), to increase the range or change the direction of the signal, it is possible to use the RFRP-20NN repeater or other units of the system with support for the repeater function.
- In the base, the head is compatible with M30x1,5 valves, adapters that are not included in the package can be used for other valves.

Device description

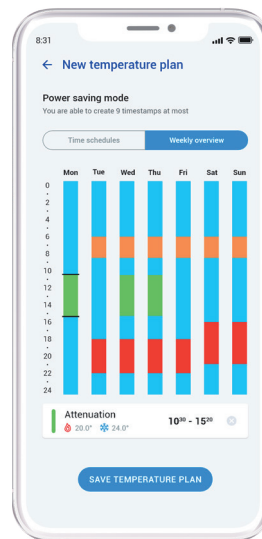
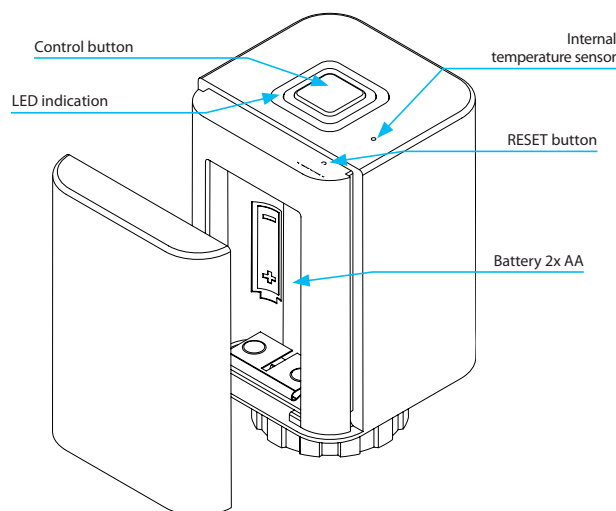

TC, TZ | Temperature sensors



EAN code:
 TC-0: 8595188110075 TC-6: 8595188110082
 TC-3: 8595188110617 TC-12: 8595188110099

Technical parameters	TC	TZ
Range:	-20 to +80 °C (-4 to 176 °F)	-40 to +125 °C (-40 to 257 °F)
Scanning element:	NTC 12K	NTC 12K
Tolerance:	±(0.15 °C + 0.002 t)	±(0.15 °C + 0.002 t)
In air/in water:	(τ0.5) ≤ 18 s	(τ65) 62 s/8 s
In air/in water:	(τ0.9) ≤ 48 s	(τ95) 216 s/23 s
Cable material:	PVC unshielded, 2x 0.25 mm ²	silicon VO3SS-F 2D x 0.5 mm ²
Terminal material:	polyamide	stainless steel
Protection degree:	IP67	IP67
Electrical strength:	2500 VAC	2500 VAC
Insulation resistance:	> 200 MΩ at 500 VDC	> 200 MΩ at 500 VDC

Types of temperature sensors:		
	TC-0	TZ-0
- length:	100 mm	110 mm
- weight:	5 g	4.5 g
	TC-3	TZ-3
- length:	3 m	3 m
- weight:	70 g	106 g
	TC-6	TZ-6
- length:	6 m	6 m
- weight:	130 g	216 g
	TC-12	TZ-12
- length:	12 m	12 m
- weight:	250 g	418 g

τ65 (95): time, which sensor needs to heat up on 65 (95) % of ambient temperature of environment, in which is located.

- Thermister temperature sensors are made of Negative Temperature Coefficient (NTC) embedded in a PVC or metal sleeve with a thermally-conductive sealer.
- **Sensor TC**
- lead-in cable to sensor TC is made of wire CYSY 2D x 0.5 mm/0.02".
- **Sensor TZ**
- cable VO3SS-F 2D x 0.5 mm/0.02" with silicone insulation for use in high temperature applications.
- silicone insulation for use in high temperature applications.
- Temperature sensors can be connected directly to the terminal block
- Cable lengths can not be changed, connected or modified.

Resistive values of sensors in dependance on temperature

Temperature (°C)	Sensor NTC (kΩ)
20	14.7
30	9.8
40	6.6
50	4.6
60	3.2
70	2.3

Tolerance of sensor NTC 12 kΩ is ± 5% by 25 °C/77 °F.

Diagramm of sensor warm up via air

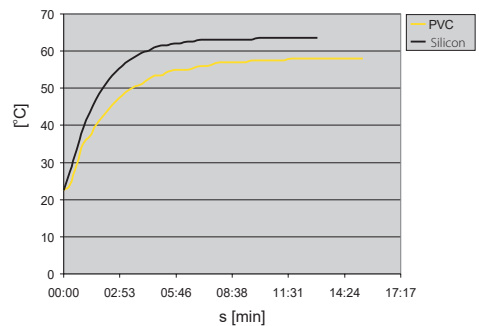

PVC -reaction to water temperature from 22.5 °C to 58 °C.
 Silicone - reaction to water temperature from 22.5 °C to 63.5 °C.

Design and dimensions

TC

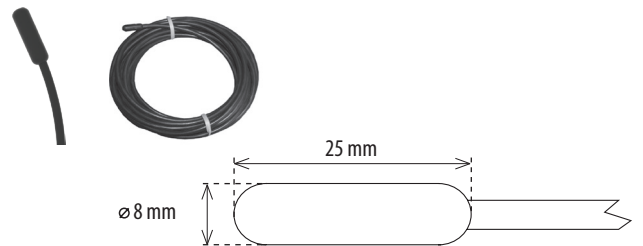

TZ

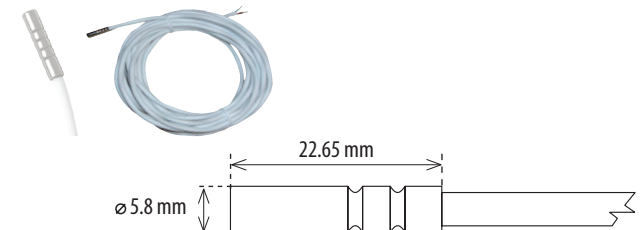

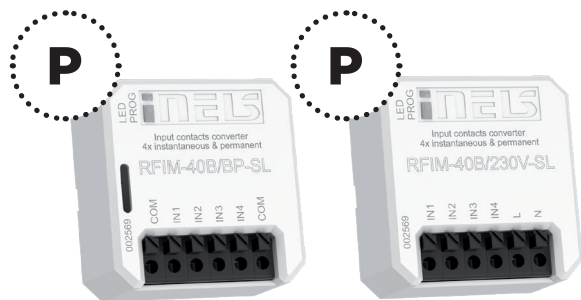

EAN code:
RFIM-40B/BP-SL: 8595188184069

RFIM-40B/230V-SL: 8595188184076

Technical parameters	RFIM-40B/BP-SL	RFIM-40B/230V-SL
Supply voltage:	1x 3 V battery CR 123A	230 V AC
Battery life:	8 years based of frequency use	
Indications/transfer function:	red LED	
Number of inputs:	4	4
Supply voltage tolerance:	+10 %; -15 %	
Control		
Communication protocol:	RFIO2	
Frequency:	866–922 MHz (for more information see p. 85)	
Repeater function:	no	
Signal transmission method:	unidirectionally addressed message	
Range:	in open space up to 200 m	
Other data		
Operating temperature:	-10 to +50 °C	
Operating position:	any	
Line resistance between terminals		
- for closed button:	< 300 Ω	
- for open contact:	> 10 kΩ	
Mounting:	free at lead-in wires	
Protection:	IP40	
Surge category:	III.	
Contamination degree:	2	
Connection:	screwless terminals	
Dimensions:	43 x 44 x 22 mm	
Weight:	37 g	25 g
Contact voltage:	3 V	230 VA
Length of cable to contact:	max. 5 m	max. 100 m
		of parallel lines
Related standards:	EN 60730, EN 63044, EN 300 220, EN 301 489	

- **RFIM-40B / BP-SL:** the wireless contact converter changes the wired button / switch to wireless.
- 4 inputs allow to control 4 devices independently,
- battery supply (3 V battery CR123A - included in the package) with a lifespan of about 8 years according to the frequency of use,
- the contact can be permanently closed.
- **RFIM-40B / 230V-SL:** the contact converter changes the button / switch with local mains supply to wireless.
- 4 inputs allow to control 4 devices independently,
- mains supply, the inputs respond to the supply of mains supply
- It can be used to transmit contact closing information (detector, buttons, technology, logic output).
- When the button is pressed, it sends the set command (ON / OFF, dimming, time off / on, pull / pull).
- Ability to set scenes where you control multiple iNELS Wireless components with a single press.
- Range up to 200 m (outdoors), in case of insufficient signal between the controller and the component, use the RFRP-20N signal repeater or elements with the RFIO2 protocol that support this function.
- The BOX version offers mounting directly in the installation box under the button / switch.
- Attention: The controller is paired with the elements using the pairing button. Ord. codes for controllers with pairing button: RFIM-40B/BP-SL Order No.: 8406, RFIM-40B/230V-SL Order No.: 8407, see Pairing controllers on p. 88.

Device description

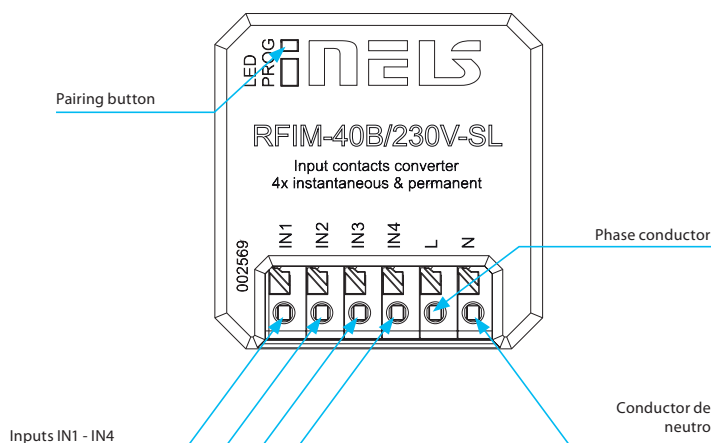
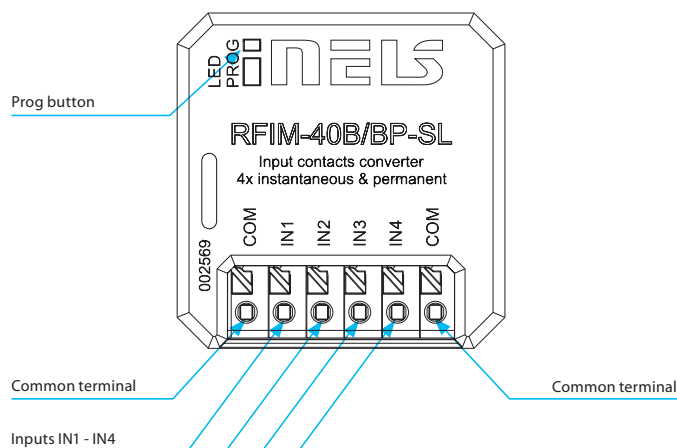

Connection

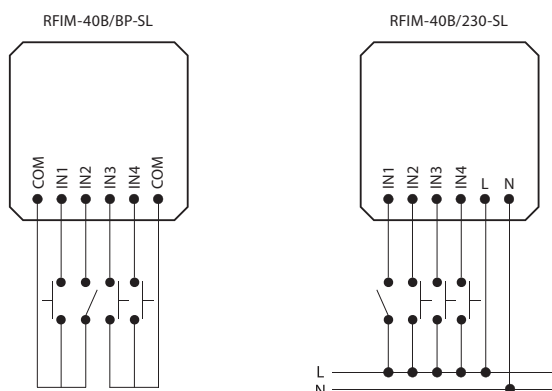



EAN code:
RFSG-1M: 8595188142847

Technical parameters		RFSG-1M
Supply voltage:		110–230 V AC
Supply voltage frequency:		50–60 Hz
Apparent input:		2 VA
Dissipated power:		0.2 W
Supply voltage tolerance:		+10 %/-25 %
Power supply indication:		green LED
Input		
Control voltage:		AC 12–230 V/DC 12–230 V
Control input power:		AC 0.025 VA/DC 0.1 W
Control terminals:		S–S
The length of control impulse:		min. 25 ms (max. unlimited)
Transmission indication/function:		red LED
Control		
Communication protocol:		RFIO
Frequency:		866–922 MHz (for more information see p. 85)
Repeater function:		no
Signal transmission method:		unidirectionally addressed message
Range:		in open space up to 160 m
Minimum control distance:		20 mm
Wireless antenna:		AN-I included (SMA connector)*
Other data		
Operating temperature:		-15 to +50 °C
Operating position:		any
Mounting:		DIN rail support EN 60715
Protection:		IP20 from the front panel
Overvoltage category:		III.
Contamination degree:		2
Connecting conductor cross-section: (mm ²):		max. 1x 2.5, max. 2x 1.5/ with a hollow max. 1x 2.5
Dimensions:		90 x 17.6 x 64 mm
Weight:		62 g
Related standards:		EN 60730, EN 63044, EN 300 220, EN 301 489

* Max Tightening Torque for antenna connector is 0.56 Nm.

- This wireless contact converter is especially appropriate for wireless transmission of information on switching HDO.
- Thanks to the permanent power supply, it can also be used for partial transmission of information for control of an appliance or device.
- After leading in power to the “S” terminals, it periodically transmits the command switch on in an interval of 2 min. When disconnecting the power supply, immediately switch off.
- The button TEST on the controller is used to assign to a switching unit.
- The package includes an internal antenna AN-I, in case of locating the converter in a metal switchboard, you can use the external antenna AN-E for better signal reception, see accessories on page 66.
- Range up to 160 m (in open space), if the signal is insufficient between the controller and unit, use the signal repeater RFRP-20N.
- 1-MODULE design of the unit with mounting into switchboard.
- The product is suitable for the transmission of control signals within photovoltaic electrical installations.
- Attention: The controller is paired with the elements using the pairing button. Ord. codes for controllers with pairing button: RFSG-1M Order No.: 8240, see Pairing controllers on p. 88.

Device description

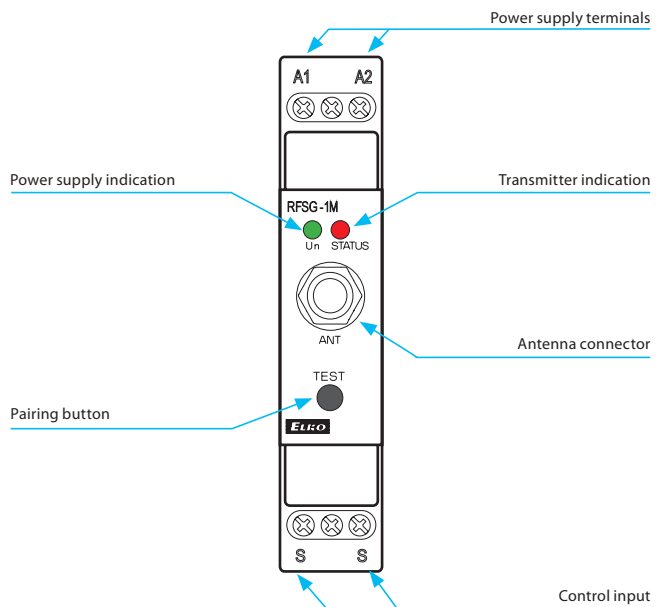

Connection

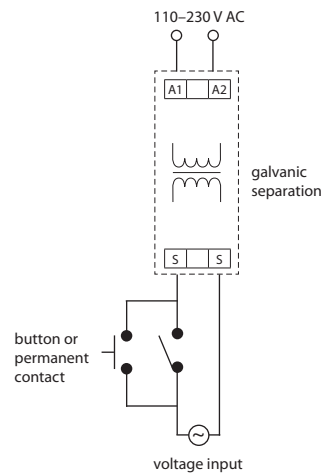



Technical parameters		RFTM-1
Power supply:	2x 1.5 AAA batteries	
Battery Life:	Appr. 2 years, (depending on the type of sensor, frequency of transmissions and pulses)	
Indication		
Setting mode:	Green LED flashes - active Red LED - flashes during impulse sensor registration	
Communications Test	Green LED - communication OK	
- Wireless STATUS:	Red LED - communication ERR	
Normal operation:	no indication	
Control		
Manual control:	button SET	
Sensor Selection:	rotary potentiometer	
Supported sensors	LS (LED sensor)	
(not included in the package):	MS, WS (magnetic sensor) S0 (Contact, open collector, reed magnetic contacts)	
Output		
Communication protocol:	RFIO	
Frequency	866–922 MHz (for more information see p. 85)	
Range:	in open space up to 100 m	
Other data		
Working temperature:	-20 to +50 °C *	
Storage temperature:	-30 to +70°C	
Operating position:	any	
Protection:	IP65	
Cross-section of connecting wires:	max. 0.5 - 1 mm ²	
Dimension:	72 x 62 x 34 mm	
Weight:	104 g	

* Pay attention to the operating temperature of batteries.

- The wireless pulse converter detects home energy meters (electric, water, gas) by means of sensors, and sends them to the wireless unit eLAN-RF-103.
- Measured values are displayed in the iNELS application iHC-MAIRF/iHC-MIIRF, in daily, weekly or monthly overview in graphs.
- The sensor is designed for use on existing meters and even without the impulse output "S0" (The gauge must support scan).
- RFTM-1 transfers consumption from meters using sensors - LS (LED sensor), WS (Magnetic sensor for meter), MS (Magnetic sensor) or by impulse output („S0“).
- For each consumption meter, it is necessary to have one pulse converter RFTM-1.
- Battery power (2x 1.5 V AAA batteries - included in package) with average battery life of around 2 years (according to the type of scan, frequency of transmissions and pulses).
- Range up to 100 m (in open space), if the signal between the controller and the user is weak, use the signal repeater RFRP-20N or protocol component RFIO2 that support this feature.
- The increased IP65 protection is appropriate for mounting in risers, switchboards and other demanding environments.

Device description

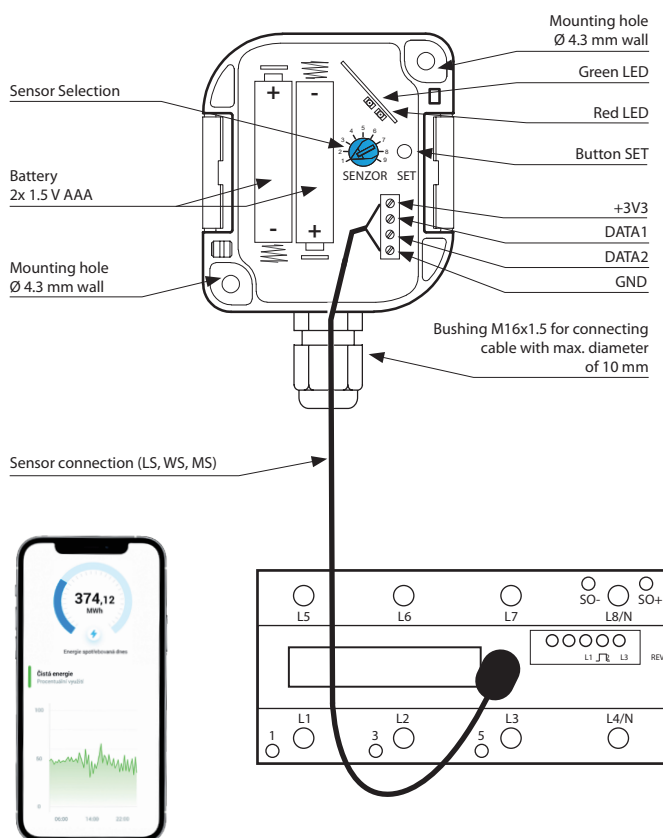



EAN code:
RFSF-100: 8595188176828

Technical parameters		RFSF-100
Power supply		
Battery power:	2x 1.5 V AAA batteries	
Battery life by frequency 1x 12 hours:	3 years	
Setting		
Alarm Detection:	optical and audible alarm	
Battery status view:	low battery is indicated by 5 flashes every 15 minutes or by display in the system element	
Acoustic signal:	greater than 45 dB/1m	
Detection		
Sensor:	contacts for flooding	
Detection principle:	contact between the sensor sensed liquid	
Response Time:	2 s after connecting the scanning contacts	
Measurement accuracy:	99.8 %	
Sensitivity:	in the range 0–170 kΩ	
Control		
Communication protocol:	RFIO	
Frequency:	866–922 MHz (for more information see p. 85)	
Repeater function:	no	
Signal transmission method:	unidirectionally addressed message	
Range:	in open space up to 160 m	
Other parameters		
Working temperature:	0 to +50 °C (Pay attention to the operating temperature of batteries)	
Storage temperature:	-20 to +60 °C	
Operation position:	capture contacts for flooding downwards	
Mounting:	loose	
Protection degree:	IP62	
Dimension:	Ø 89 x 23 mm	
Weight:	92 g	
Related standards:	EN 60730, EN 63044, EN 301489, EN 300 220	

- The flood detector is used to detect water leakage - the activation occurs the moment the flooding of the contacts located on the underside of the detector occurs.
- Upon detecting water, the flood detector immediately sends a signal to the switched unit, which further switches on a pump or closes a pipe valve.
- Flood detection is signalled by optical and acoustic signalling.
- Range up to 160 m (in open space); if the signal is insufficient between the controller and unit, use the signal repeater RFRP-20N or protocol component RFIO2 that support this feature.

Description

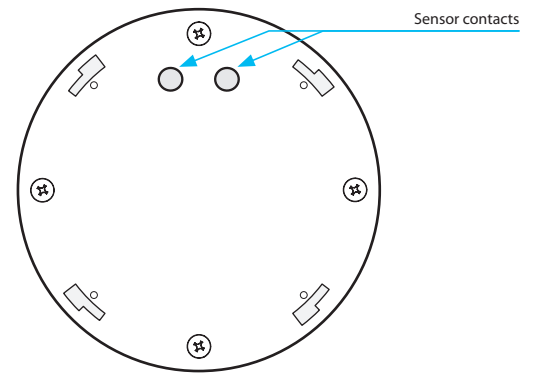

Function

When the scanning contact is connected, the detector sends the message and starts alarm.

Conductivity of liquids

Liquids suitable for detection		Inadmissible liquids
Type of liquid	Resistivity [Ωcm]*	
Drinking water	5–10 kΩ	Demineralised water
Well water	2–5 kΩ	Deionised water
River water	2–15 kΩ	Bourbon
Rain water	15–25 kΩ	Gasoline
Waste water	0.5–2 kΩ	Oil
Seawater	~0.03 kΩ	Liquid gases
Salt water	~2.2 kΩ	Paraffin
Natural/hard water	~5 kΩ	Ethylene glycol
Chlorinated water	~5 kΩ	Paints
Condensed water	~18 kΩ	High alcohol-content liquids
Milk	~1 kΩ	
Milk serum	~1 kΩ	
Fruit juices	~1 kΩ	
Vegetable Juices	~1 kΩ	
Broths	~1 kΩ	
Wine	~2.2 kΩ	
Beer	~2.2 kΩ	
Coffee	~2.2 kΩ	
Soap toam	~18 kΩ	

* Resistivity characterizes the resistive properties of materials which conduct electric current.



EAN code:
RFSOU-1: 8595188147071

Technical parameters	RFSOU-1
Power supply:	2 x 1.5 AAA batteries
Battery Life:	Appr. 2 years, according to the number of controlled units
Setting the range of light levels	
Function ☾ (twilight switch)	
- Range 1:	1 to 10 lx
- Range 2:	10 to 100 lx
- Range 3:	100 to 1.000 lx
Function ☀ (light switch)	
- Range 1:	100 to 1 000 lx
- Range 2:	1 000 to 10 000 lx
- Range 3:	10 000 to 100 000 lx
Function setting:	rotary switch
The level of lighting gently:	0.1 to 1 x range
Fine adjustment of lighting levels:	potentiometer
The time delay t:	0/1 min./2 min.
Setting the delay time t:	rotary switch
Control	
Communication protocol:	RFIO
Frequency:	866–922 MHz (for more information see p. 85)
Repeater function:	no
Range:	in open space up to 160 m
Other data	
Working temperature:	-20 to +50 °C
Storage temperature:	-30 to +70 °C
Operating position:	sensor side down
Protection:	IP65
Degree of pollution:	2
Dimension:	72 x 62 x 34 mm
Weight:	104 g
Standards:	EN 60730, EN 63044, EN 300 220, EN 301 489

- The twilight switch measures the light intensity and based on a set value, it sends the command to switch on the lights or pull the blinds up or down.
- It can be combined with multifunctional switching units and blind switches.
- Integrated sensor for measuring illumination, settable in 3 ranges 1-100,000 lx.
- Selection of function:
 - a) twilight switch – automatically switches on upon a decrease in ambient light intensity, switches off upon an increase (appropriate for garden lights, advertisements, public lighting, etc.).
 - b) light switch – automatically switches on upon an increase in ambient light intensity, switches off upon a decrease (appropriate for offices, restaurants, rooms, etc.).
- Settable delay up to 2 minutes to eliminate unwanted switching caused by surrounding influences.
- The twilight switch may control up to 32 units in the installation.
- The programming button on the regulator is used for:
 - a) setting a function with a switching or blind unit
 - b) ascertaining battery status
 - c) ascertaining signal quality between the unit and dimmer.
- Battery power (2x 1.5 V AAA batteries - included in supply) with battery life of around 2 years based on the number of controlled units.
- Range up to 160 m (in open space), if the signal is insufficient between the controller and unit, use the signal repeater RFRP-20N or protocol component RFIO2 that support this feature.

Device description

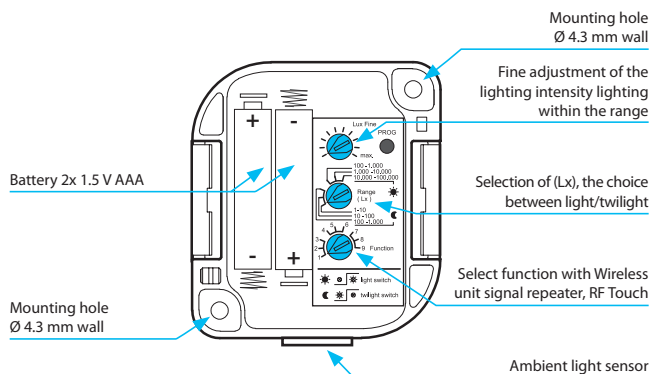



EAN code:
RFWD-100: 8595188150279

Technical parameters	RFWD-100
Power supply:	1x 3 V CR 2032 battery
Drained battery indicator:	yes
Control	
Communication protocol:	RFIO
Frequency:	866–922 MHz (for more information see p. 85)
Repeater function:	no
Other data	
Working temperature:	-10 to +50 °C
Protection:	IP20
Colour:	white
Dimension:	25 x 75 x 16 mm
Magnet dimension:	15 x 75 x 14 mm
Standards:	EN 60730, EN 63044, EN 301489, EN 300 220

- The Window/Door detector is used to detect opening where activation occurs when the magnet and the sensor become separated.
- Use:
 - in combination with the switching unit for automatic light control (cellar, garage, etc.).
 - by means of the Smart RF gate, detection can be displayed on your smart phone in the form of a notification; alarms are stored in the history, which is visualized in the iNELS application.
- Anti-tamper function: an alarm is triggered if there is an unauthorized interference to detector.
- Power supply: 1x 3 V CR 2032 battery, the battery life is around 1 year, thanks to the ability to turn off the LED indicator it is possible to extend up to 3 years.
- “Low Battery” Alerts on Your iNELS App.
- The detectors are compatible with switching components marked with the RFIO2 communication protocol and the eLAN-RF system components.



EAN code:
RFMD-100: 8595188150293

Technical parameters		RFMD-100
Power supply:	2x 1.5 V AA batteries	
Battery life:	up to 1 year, according to the number of activations	
Drained battery indicator:	yes	
Control		
Communication protocol:	RFIO	
Frequency:	866–922 MHz (for more information see p. 85)	
Repeater function:	no	
Detection angle:	105°	
Detection distance:	max. 12 m	
Recommended working height:	max. 2.4 m	
Other data		
Working temperature:	-10 to +50 °C	
Protection:	IP20	
Colour:	white	
Dimension:	46 x 105 x 43 mm	
Weight:	57 g	
EMC resistance:	level 2	
Related standards:	EN 60730, EN 63044, EN 301489, EN 300 220	

- The motion detector PIR is used to detect persons moving inside the building interior.
- Use:
 - in combination with a switching unit for automatic control of lighting or triggering an alarm.
 - by means of the Smart RF gate, detection can be displayed on your smart phone in the form of a notification; alarms are stored in the history, which is visualized in the iNELS application.
- Sensitivity settings of the PIR detector for eliminating unwanted triggering.
- Integrated lighting sensor, thanks to which you can set the detector's reaction time.
- Option of activation/deactivation of the LED indicator on the detector cover.
- Anti-tamper function: an alarm is triggered if there is an unauthorized interference to detector.
- Power supply: 2x 1.5 V AA batteries, the battery life is around 1 year.
- "Low Battery" Alerts by double LED flashing or on iHC App.
- The detectors are compatible with switching components marked with the RFIO2 communication protocol and the eLAN-Wireless system components.

Detection field

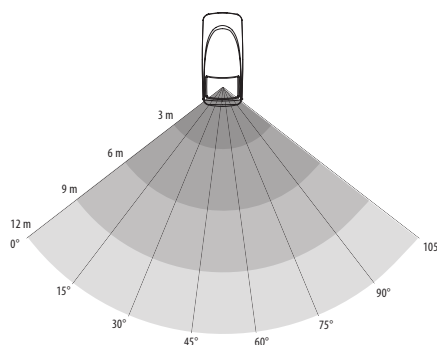



EAN code:
RFMD-200: 8595188189194

Technical parameters	RFMD-200
Power supply:	2x 1.5 V AA batteries
Battery life:	up to 1 year, according to the number of activations
Drained battery indicator:	yes
Control	
Communication protocol:	RFIO
Frequency:	866–922 MHz (for more information see p. 85)
Repeater function:	no
Detection angle:	110°
Detection distance:	max. 9.5 m
Recommended working height:	max. 2.5 m
Other data	
Working temperature:	-10 to +50 °C
Protection:	IP20
Colour:	white
Dimension:	ø 95mm, height incl. lens 30mm
Weight:	113 g
Related standards:	EN 60730, EN 63044, EN 301489, EN 300 220

- The motion detector PIR is used to detect presence persons moving inside the building interior.
- Use:
 - in combination with a switching unit for automatic control of lighting or triggering an alarm.
 - by means of the Smart RF gate, detection can be displayed on your smart phone in the form of a notification; alarms are stored in the history, which is visualized in the iNELS application.
- In combination with hotel elements (HRESK) it can serve as a room occupancy sensor
- Sensitivity settings of the PIR detector for eliminating unwanted triggering.
- Option of activation/deactivation of the LED indicator on the detector cover.
- Power supply: 2x 1.5 V AA batteries, the battery life is around 1 year.
- "Low Battery" Alerts by double LED flashing or on iHC App.
- The detectors are compatible with switching components marked with the RFIO2 communication protocol and the eLAN-Wireless system components.

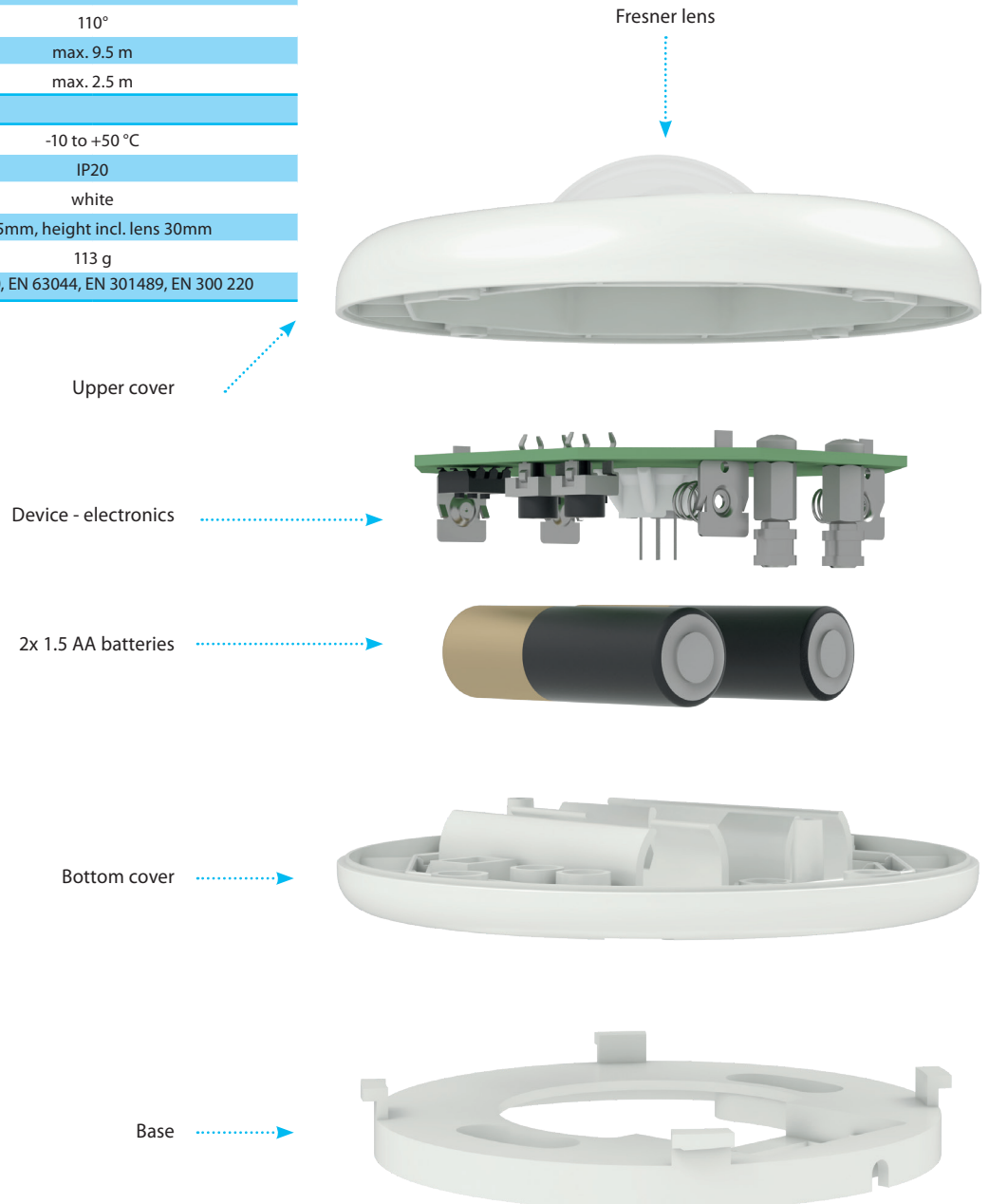



EAN code:
8595188183994

Technical parameters		RFSLT-S3
Power supply	Battery (lithium cell, 3V6-AA-LS)	
Input	Pressure sensor with digital connection	
Probe cable length:	standard 3m	
Measuring range:	standard 0-3m H ₂ O (other by agreement)	
Measurement frequency:	1x / 2.5 min (configurable)	
Output		
Relay:	up to 6 relays	
Output update frequency:	after every measurement	
Accuracy:	± 0,5%	
Time response:	≤ 100ms	
long-term stability:	≤ ± 0,2 % span / year under reference conditions	
Mechanical stability:		
vibrations	10g, 25 Hz...2 kHz	
shocks	100g / 1ms	
Electrical resistance		
Short circuit protection:	permanent	
Reverse polarity protection:	approx. 1 year (according to ambient temperature cycling)	
Electromagnetic compatibility:	radiation and immunity to interference according to EN 61326	
Control		
<i>INELS standard</i>		
Communication protocol:	RFIO	
Frequency:	866–922 MHz (for more information see p. 77)	
Repeater function:	no	
Manual control:	application	
Range:	in open space up to 200 m	
<i>Bluetooth</i>		
Communication protocol:	Bluetooth Low Energy	
Frequency:	2.4GHz	
Repeater function:	no	
Manual control:	application	
Range:	in open space up to 50 m	
Other data		
Operating temperature:	–20 ... +40 °C	
Working position:	any	
Mounting:	screws	
Protection:	IP65, probe IP68	
Recommended power cable:	The sensor including the cable is included in the package	
Dimension:	136 x 62 x 34 mm	
Weight:	150 g	
Standards:	EN 60730, EN 63044, EN 300 220, EN 301 489, EN 300 328	

- It measures the level of liquids based on the principle of hydrostatic pressure measurement.
- It consists of a communication unit in a plastic case with IP65 protection placed above the surface and a stainless steel pressure probe connected by a cable lowered to the bottom of the tank.
- The standard length of the probe cable is 3m or 9m.
- The unit communicates wirelessly via the RFIO2 protocol with the devices of the iNELS RF Control system and is powered by a 3V6 lithium battery. The range of the switching actuators from the unit is determined by the building/location, in open space it is normally 200 meters.
- The unit can also communicate with the eLAN-RF-103 gateway, which conveys level information to the iNELS application.
- In the application, it is possible to manage switching actors, edit notifications, continuously monitor the level, pressure, temperature and battery discharge status in the unit.
- The unit itself is set up via the iSonda application from an Android/iOS smartphone via the Bluetooth interface (LowEnergy, 4.1 and higher).

Function

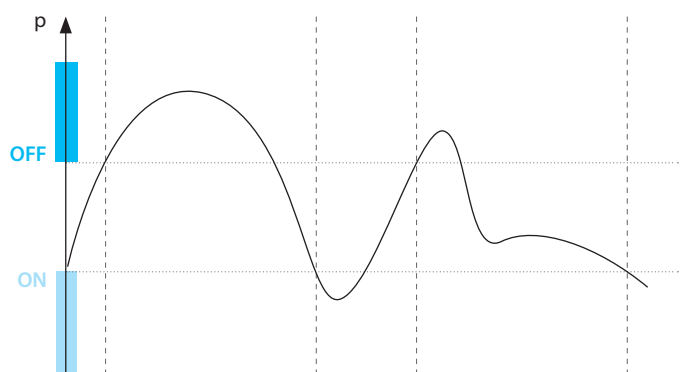
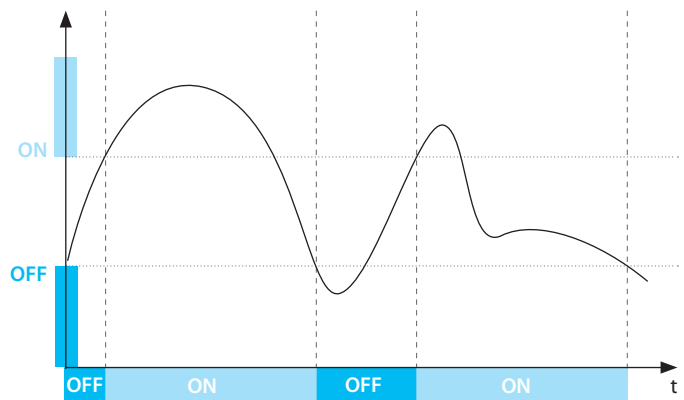

Materials (in contact with the medium)

Housing:	stainless steel 1.4301 (304)
Seal:	FKM
Membrane:	stainless steel 1.4435 (316 L)
Cable jacket:	PUR

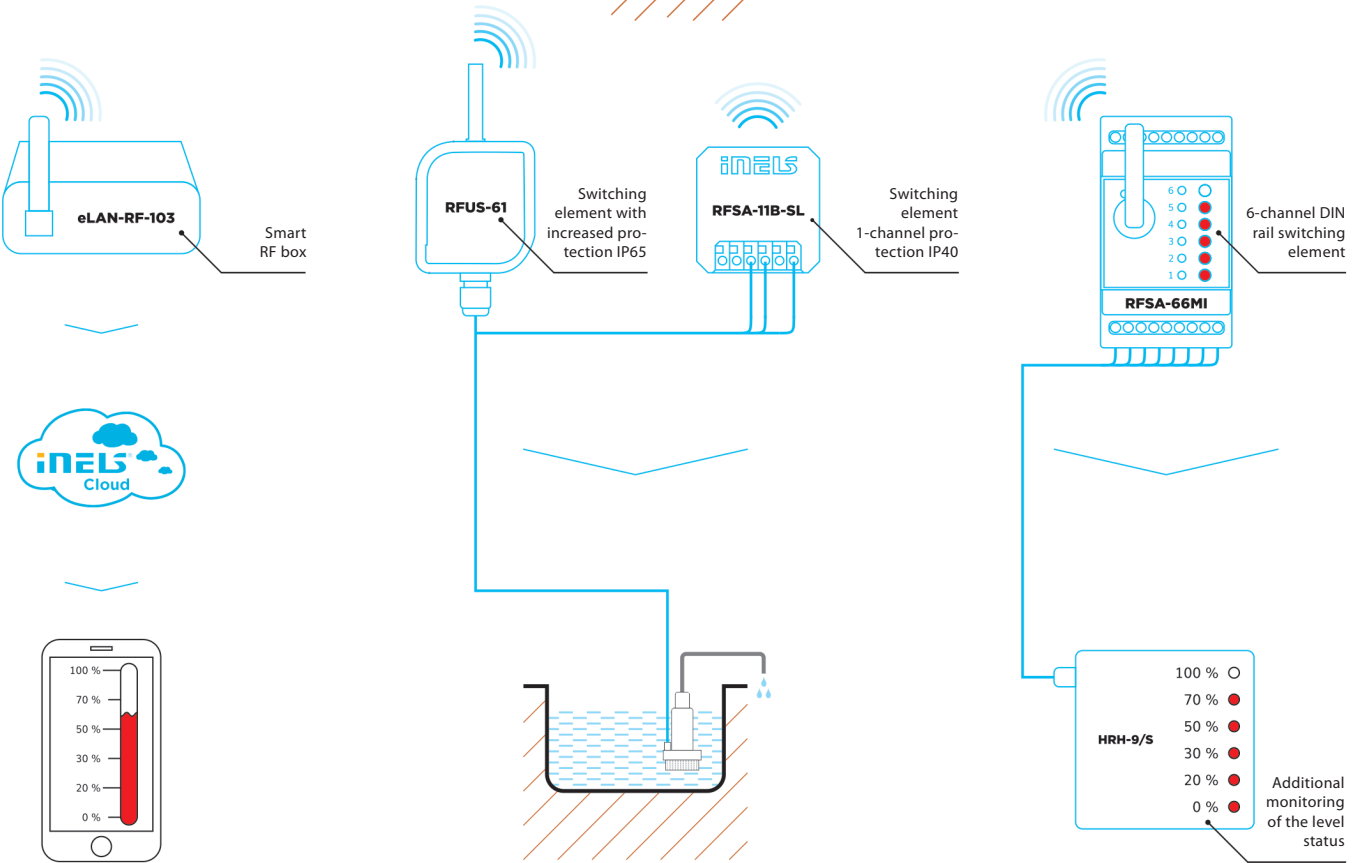
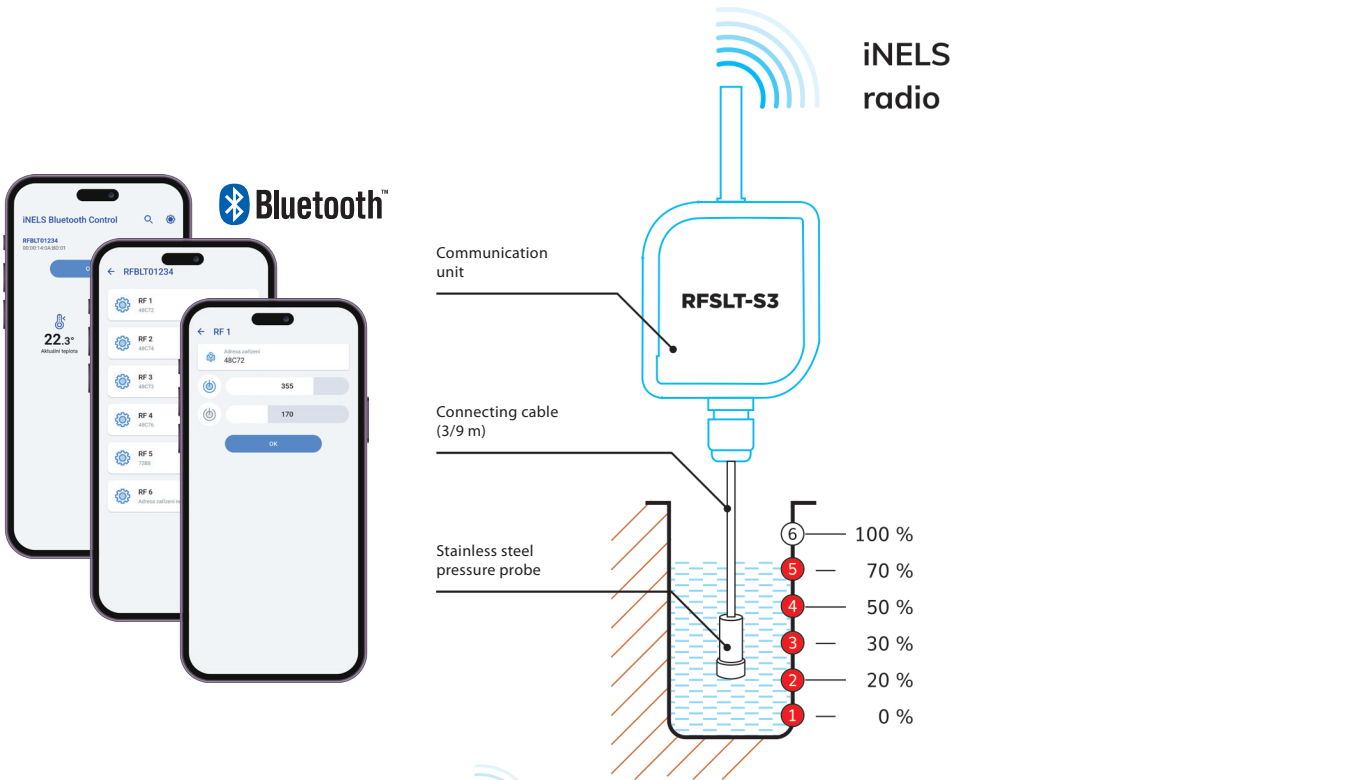

Signaling via the application on the phone

Control of 1 pump: **RFS-11B-SL, RFUS-61**
Control of 2 pumps: **RFS-62B-SL**

Control/signaling, 6x output
(eg: MAX / MIN / CRITICAL MAX / CRITICAL MIN)



EAN code:
RF TOUCH-2/BE: 8595188182669
RF TOUCH-2/BR: 8595188189743

Technical parameters	RF Touch-2/BE	RF Touch-2/BR
Display		
Type:	color TFT LCD 4"	
Distinction:	480 x 480 pixels	
Aspect Ratio:	72 x 72 mm	
Visible area:	active (white LED)	
Backlight:	capacitive	
Power supply		
USB-C	5V	5V
Passive PoE:	24V	—
Terminal plate:	(10-30V DC)	
Power consumption:	max. 3 W	
Communication		
Radio		
Communication protocol:	RFIO2	
Frequency:	866–922 MHz (for more information see p.81)	
Range:	open space up to 200 m	
Min. distance RF Touch component:	1 m	
WiFi		
Protocols:	802.11 b/g/n (802.11n to 150 Mbps) A-MPDU and A-MSDU	
Frequency:	2.4 GHz	
LAN		
Ethernet:	100 Mbit/s	
Sensors and notifications		
Temperature sensor	0-50 °C; 0.2 °C out of range	
Humidity sensor	0-100%; 2% of range (RH)	
Proximity sensor	15cm	
Notification LED	RGB	
Operating conditions		
Operating temperature:	0 to +50 °C	
Storage temperature:	- 20 to +70 °C	
Cover:	IP20	
Surge category:	III.	
Degree of pollution:	2	
Working position:	any	
Installation:	into the installation box	
Dimensions:	86 x 86 x 10 (37)	
Weight (plastic):	120 g	
Related standards:	EN 60730, EN 63044, EN 300 220, EN 301 489, EN 300 328	

- RF Touch-2 touch control unit is a system element used for automatic and manual control of switching, dimming, or blind elements and heating control elements within the iNELS Wireless system.
- The control unit is available in two versions:
 - RF Touch-2/BE – professional version powered via PoE, USB-C, or 10-30V DC screwless terminals and communicating via Wi-Fi and LAN for connection in new home installations, hotels, hospitals, and office buildings
 - RF Touch-2/BR – simpler version with powered via USB-C or 10-30V DC screwless terminals and communicating via Wi-Fi for easy connection in renovated rooms without having to connect to the local network
- Both versions communicate wirelessly with iNELS Wireless units using radio frequency and allow up to 40 wireless element addresses and 30 detectors to be connected in this way.
- RF Touch-2 touch unit also serves as a communication gateway, so besides direct control via the 4" capacitive display, it allows communication with the system via the iNELS app and provides connection to the iNELS Cloud.
- A great advantage of the unit is that it supports the MQTT protocol, thus allowing controlling it via HomeKit, Home Assistant, and other Smart Home and professional BMS integrations.
- RF Touch-2 unit offers a range of automatic functions that can be used even when not connected to a local network, such as controlling heating modes, timers, light scenes, and leaving buttons.
- RF Touch-2 features integrated temperature and humidity sensors for controlling heating modes and a proximity sensor for non-contact lighting of the display.
- Innovative design allows for easy installation in a mounting box

Device description

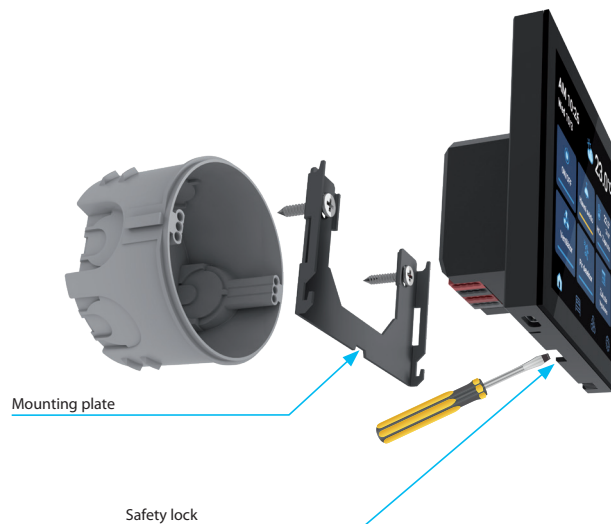
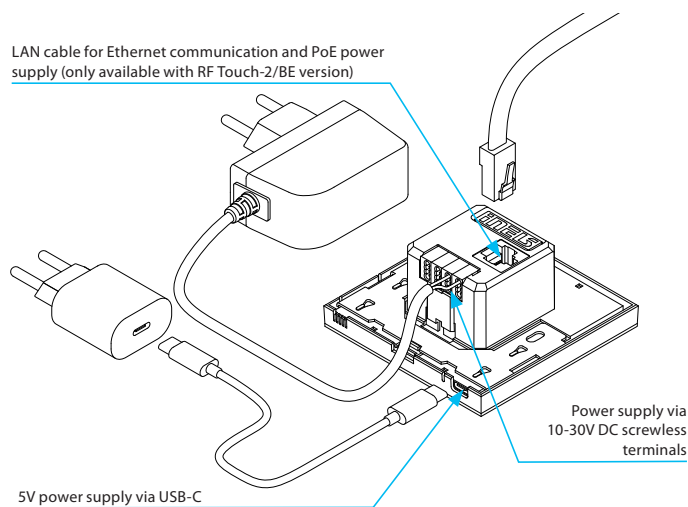

Communication diagram

Communication with RF Touch-2 can be direct (fixed IP) or indirect (via iNELS cloud).



Screen preview





EAN code:
eLAN-RF-103: 8595188180443

Technical parameters eLAN-RF-103

Interface Wireless Control

Communication protocol:	RFIO2
Broadcasting frequency:	866–922 MHz (for more information see p. 85)
Signal transfer method:	two-way addressed message
Output for antenna:	SMA connector*
Antenna Wireless:	AN-I 1 dB
Indications Wireless communications:	1x green RF LED
Range:	in open space up to 100 m

Interface Ethernet

ETH operating status indicator:	green LED
ETH communication indicator:	yellow LED
Communications interface:	100 Mbps (RJ45)
Preset IP address:	DHCP

Power supply

Supply voltage/current:	5 V DC/0.5 A
Power source:	110–230 V AC/5 V DC–2 A (connector USB-C)
Button RESET	
- short press:	restart the device
- press > 5 s	reset network settings
- press > 10 s:	reset to factory settings

Indication LED STATUS

- green:	normal mode
- red:	error condition
- orange:	initialization/start

Other data

Operating temperature:	-20 to +50 °C
Storage temperature:	-25 to +70 °C
Protection:	IP20
Contamination degree:	2
Working position:	any
Dimensions:	90 x 52 x 65 mm
Weight:	136 g
Related standards:	EN 60730, EN 63044, EN 300 220, EN 301 489

* Max Tightening Torque for antenna connector is 0.56 Nm.

- The Smart Wireless Box is a gateway between iNELS Wireless elements and applications for smartphones, tablets, watches, televisions, voice assistants (Google Home & Alexa) and other third-party devices.
- It is produced in two versions:
 - a) eLAN-RF-103: LAN communication
- It communicates from up to 70 iNELS Wireless elements, processes set programs for automatic control.
- Thanks to two-way communication, it displays the current status of individual elements.
- Powered by 5 V DC/2 A adapter, USB-C connector (included).
- Configuration is done via the iHC application.
- The package includes an internal antenna AN-I, in case the Smart Wireless gate is located in a metal switchboard, you can use the external antenna AN-E for better signal reception, see accessories on p. 76. For the eLAN-RF-Wi-103 version.
- Supports the MQTT protocol, which enables two-way communication between the eLAN-RF-103 and therefore also with the entire iNELS Wireless system with platforms such as Home Assistant, HomeKit and other Smart Home and building management systems.

Device description

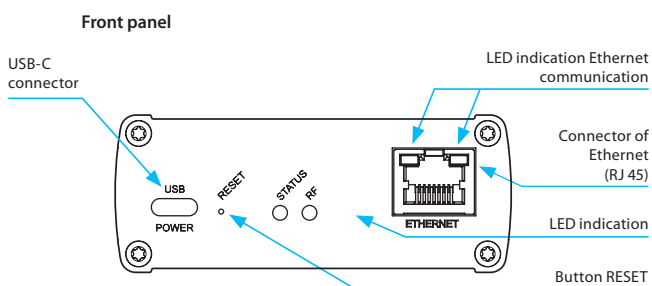

Back panel

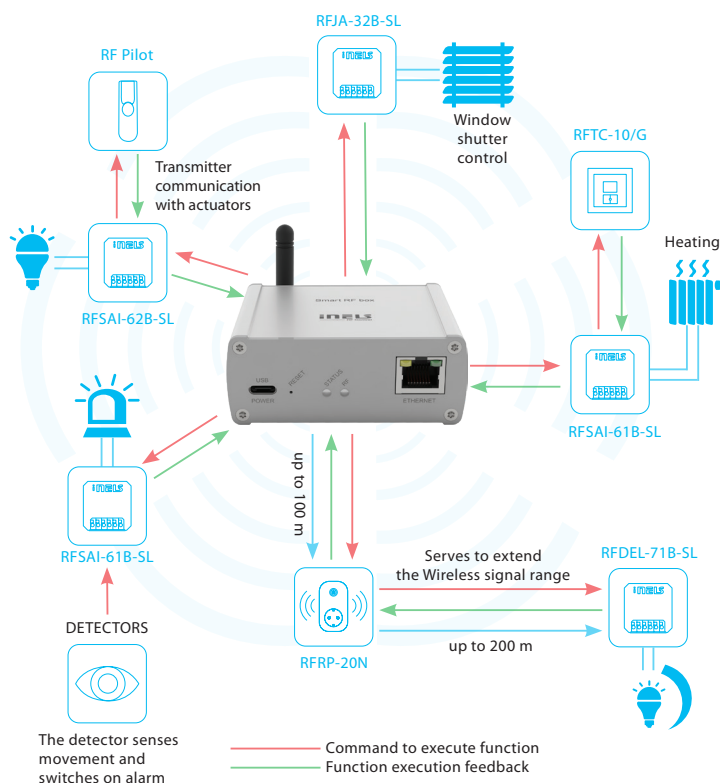
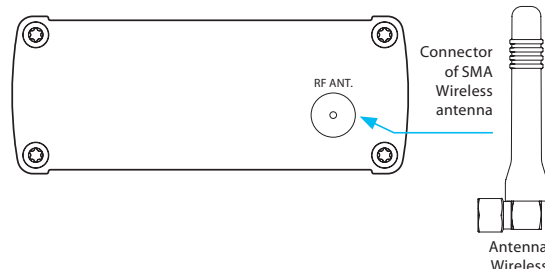



- The signal repeater is used to increase the range between the controller and the device by up to 200 meters.
- It is designed for signal transmission up to 20 components.
- Indications:
 - green LED - supply voltage,
 - red LED - active status (receiving and transmitting Wireless signal).
- Programming is done with the key.
- Thanks to the socket design, installation is simple by plugging it directly into the existing socket, the function of the through socket will be retained.

EAN code:
 RFRP-20NN/Schuko: 8595188145473 RFRP-20NN/British: 8595188145480
 RFRP-20NN/French: 8595188145107

Technical parameters		RFRP-20N/230V
Supply voltage:	230V	
Supply voltage frequency:	50-60 Hz	
Apparent input:	7 VA / $\cos \varphi = 0.1$	
Dissipated power:	0.7 W	
Supply voltage tolerance:	+10%/-15%	
Control		
Communication protocol:	RFIO2	
Frequency:	866-922 MHz (for more information see p. 85)	
Range:	in open space up to 200 m	
Minimum control distance:	20 mm	
Programming:	button - green LED/red LED	
Other data		
Operating temperature:	-20 to +55 °C	
Storage temperature:	-30 to +70 °C	
Mounting:	plug into a socket	
Protection:	IP20 Device	
Dimensions:	63 x 110 x 74 mm	
Weight:	115 g	
Related standards:	EN 60730, EN 63044, EN 300 220, EN 301 489	

Produced in 3 designs of sockets/plugs:

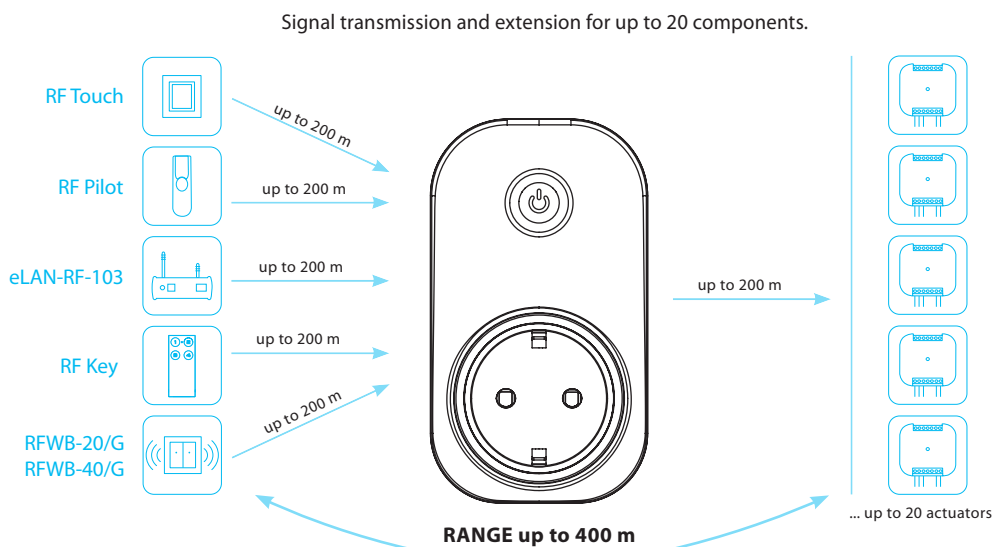

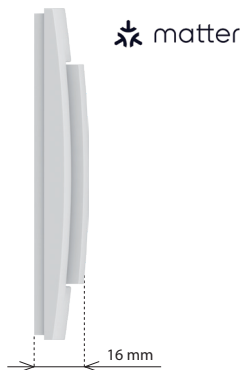
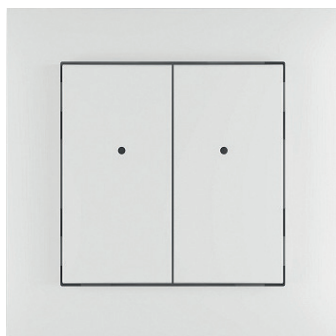

 matter

EAN code:
RFWB-40G/MT: 8595188189545

- The pushbutton type wall-mounted controllers are used to control switches and dimmers (of lights, barriers, gates, window shutters, etc.).
- It communicates on the Thread protocol that guarantees compatibility with other products with the Matter support.
- Its flat design with a flat base predestines it for quick installation on any surface (by sticking or screwing it onto a junction box).
- After a short pressing the pushbutton, it transmits the preset command (short pressing, long pressing).
- Transmission of the command is indicated by a red LED.
- Design of the LOGUS90 switch frames (plastics, glass, wood, metal, stone).
- Battery power supply (3V battery CR 2032 is included) with lifetime of approx. 2 years, depending on the frequency of use.
- The applicable reach is up to 200m (in free area).
- The element with the actuator can be paired through a border router supporting Matter and through an application supporting Matter. The border router is understood as equipment such as HomePod Mini, Google Nest Hub or Samsung SmartThings Station.

Technical parameters	RFWB-40G/MT
Supply voltage:	3 V CR 2032 battery
Battery life:	around 2 years based on frequency of use
Transmission indication:	red LED
Number of buttons:	4
Application protocol:	Matter
Communication protocol:	THREAD
Frequency:	2,4 GHz
Signal transmission method:	MESH
Range:	in open space up to 200 m

Other data	
Operating temperature:	-10 to +50 °C
Operating position:	any
Mounting:	glue/screws
Protection:	IP20
Contamination degree:	2
Dimensions frame	
- plastic:	85 x 85 x 16 mm
- metal, glass, wood, granite:	94 x 94 x 16 mm
Weight (plastic):	39 g
Related standards:	EN 60730, EN 63044, EN 301489, EN 300328

Device description

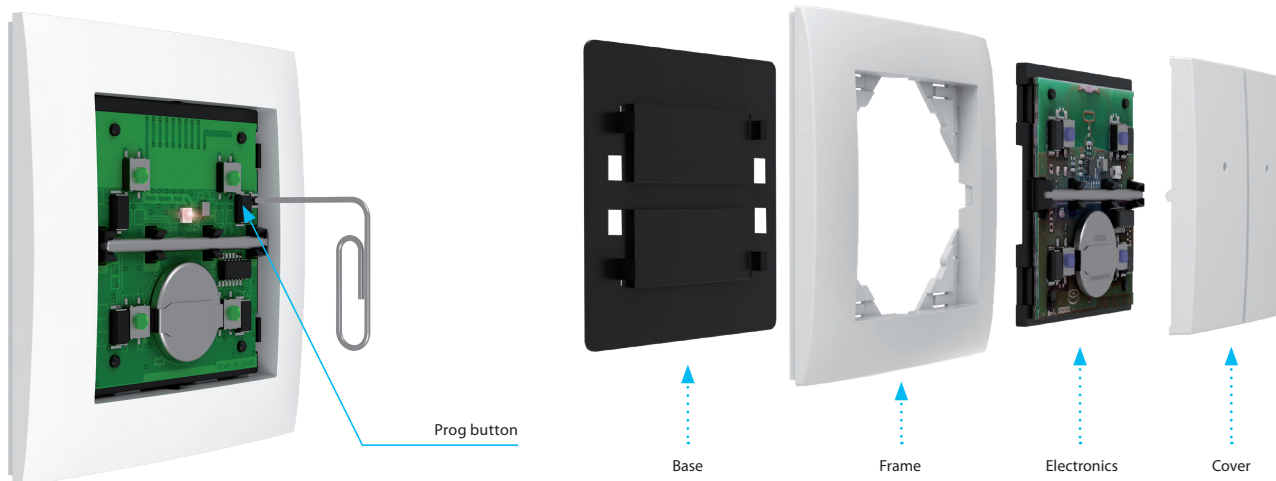
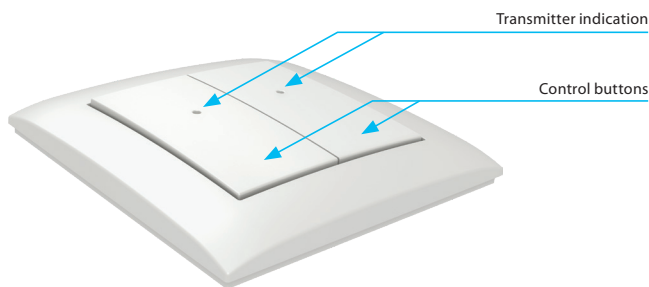

LOGUS⁹⁰

Choose your own style

Flat wireless switches that can be mounted on glass, tile, furniture ...
Such a quick change of location when you're moving.

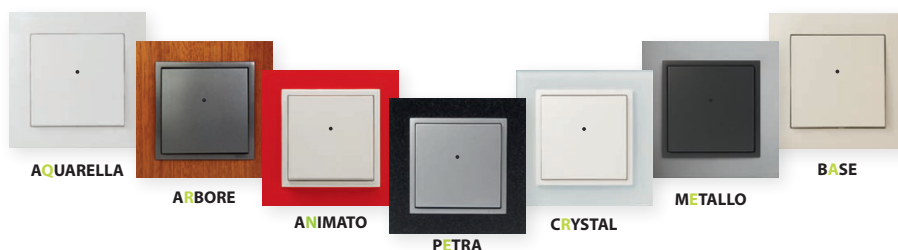

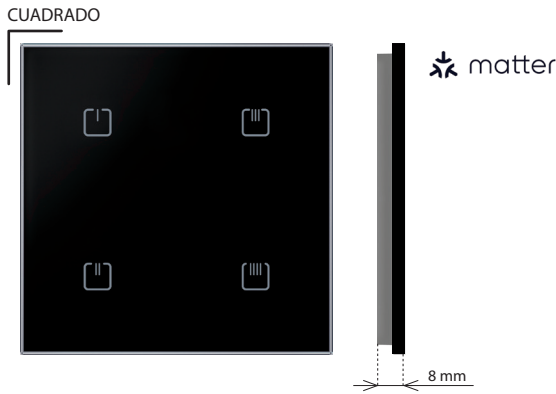

- Glass touch controller in an elegant black or white glass variant with a width of only 8 mm.
- Communicating on the Thread protocol, which guarantees compatibility with other Matter-enabled products.
- 4 capacitive buttons allow you to control 4 independent devices.
- After pressing the button, it sends the set command (short press, long press). Sending a command is indicated by a red LED.
- The flat mounting base allows installation with screws, double-sided tape or placement on the table.
- Battery power (2x 3 V batteries CR 2032 - part of the package) with a lifespan of approx. 2 years depending on the frequency of use.
- Range up to 200 m (in open space).
- The element with the actuator can be paired through a border router supporting Matter and through an application supporting Matter. The border router is understood as equipment such as HomePod Mini, Google Nest Hub or Samsung SmartThings Station.

EAN code:
 RFGB-40W/MT: 8595188189774
 RFGB-40B/MT: 8595188189767

Technical parameters		RFGB-40B/MT, RFGB-40W/MT
Supply voltage:		2x 3 V CR 2032 batteries
Battery life:		around 2 years based on frequency of use
Transmission indication:		red LED
Number of capacitive buttons:		4
Application protocol:		Matter
Communication protocol:		THREAD
Frequency:		2.4 GHz
Signal transmission method:		MESH
Range:		in open space up to 200 m
Other data		
Operating temperature:		-10 to +50 °C
Operating position:		any
Mounting:		glue/screws
Protection:		IP20
Contamination degree:		2
Dimensions:		94 x 94 x 8 mm
Weight:		101 g
Related standards:		EN 60730, EN 63044, EN 301489, EN 300328

Device description

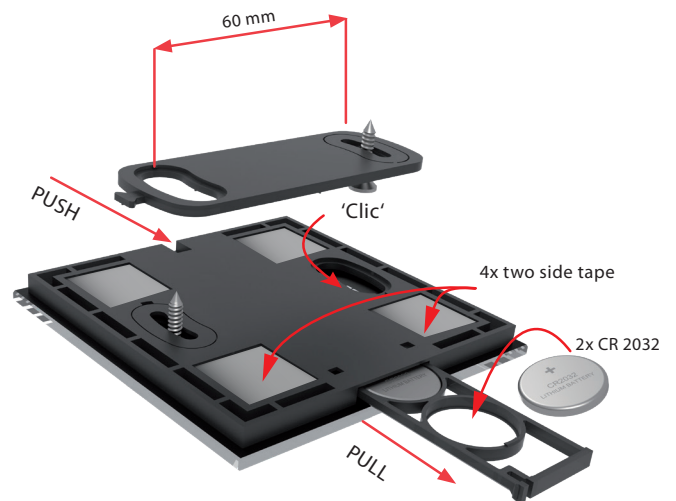
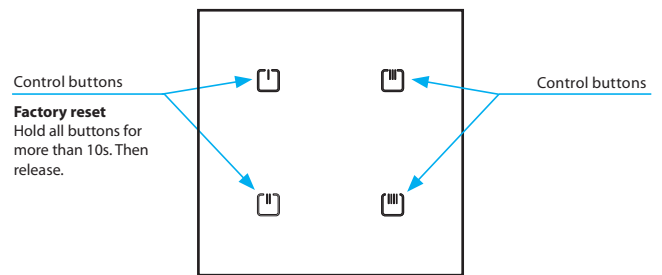

Variants

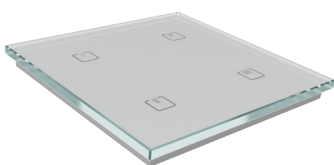

RFGB-40W/MT

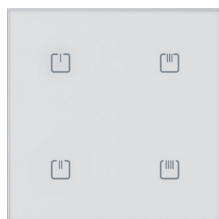

RFGB-40W/MT



RFGB-40B/MT

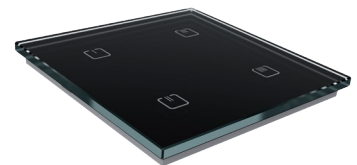

RFGB-40B/MT

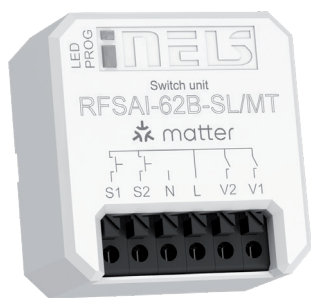

EAN code:
RFSAI-62B-SL/MT: 8595188189750

Technical parameters	RFSAI-62B-SL/MT
Supply voltage:	230 V AC
Supply voltage frequency:	50-60 Hz
Apparent input:	7 VA / $\cos \varphi = 0.1$
Dissipated power:	0.7 W
Supply voltage tolerance:	+10 %; -15 %
Output	
Number of contacts:	2x switching
Rated current:	8 A / AC1 (in total)
Switching power:	2000 VA / AC1
Peak current:	10 A / <3 s
Switching voltage:	250 V AC1
Mechanical service life:	10 mill.
Electrical service life (AC1):	100 thousand
Control	
Application protocol:	Matter
Communication protocol:	THREAD
Method of signal transmission:	MENH
Frequency:	2.4 GHz
Manual control:	button PROG (ON/OFF)
External button / switch:	yes, opposite the L terminal
Range:	in open space up to 200 m
Other data	
Operating temperature:	-15 to + 50 °C
Operating position:	any
Mounting:	free at lead-in wires
Protection:	IP40
Overvoltage category:	III.
Contamination degree:	2
Connection:	screwless terminals
Connecting conductor:	0.2-1.5 mm ² solid/fl exible
Dimensions:	43 x 44 x 22 mm
Weight:	36 g
Related standards:	EN 60730, EN 63044, EN 301489, EN 300328

- The switching element with two output relays can be used to control some appliances and lights.
- The Thread protocol guarantees compatibility with other products with the Matter support.
- The wireless controllers (RFGB-40/MT) and also the existing wired switches/pushbuttons can be used for control.
- The BOX-SL design offers installation directly in the junction box, soffit or cover of the controlled appliance. Easy connection of wires thanks to the screw-free terminals.
- The applicable reach is up to 200m (in free area).
- The maximum switched power is 2000W (8A), the relay contact material AgSnO₂ + Zero Cross predestines it for switching of lighting loads.
- The reset pushbutton on the element can also be used as manual control of the input.
- The element with the controller can be paired through a border router supporting Matter and through an application supporting Matter. The border router is understood as equipment such as HomePod Mini, Google Nest Hub or Samsung SmartThings Station.

Device description

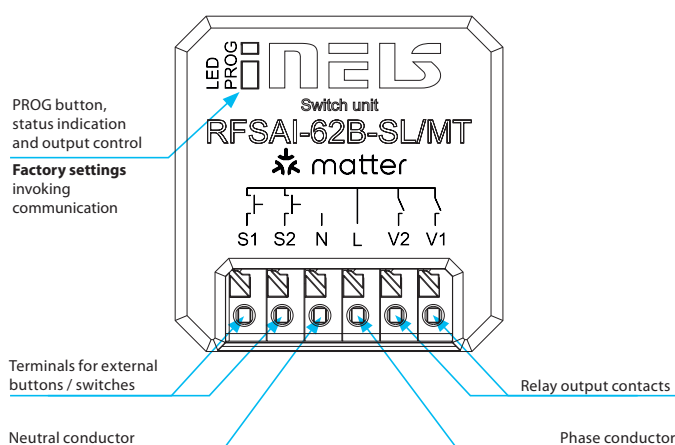

Connection

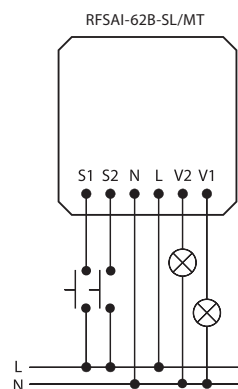

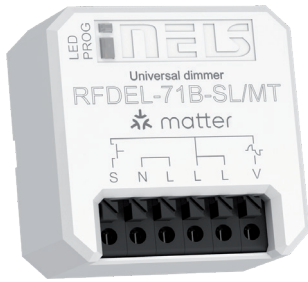

EAN code:
RFDEL-71B-SL: 8595188189552

Technical parameters	RFDEL-71B-SL/MT
Supply voltage:	230 V AC / 50 Hz
Supply voltage frequency:	50-60 Hz
Apparent power:	5 VA / $\cos \varphi = 0.1$
Dissipated power:	0.5 W
Supply voltage tolerance:	+10/ -15 %
Connection:	4-wire, with "NEUTRAL"
Output	
Dimmed load:	R, L, C, LED, ESL
Contactless:	2 x MOSFET
Load capacity*:	max. 300 W*
Control	
Application protocol:	Matter
Communication protocol:	THREAD
Signal transmission method:	MESH
Frequency:	2.4 GHz
Range:	up to 200 m
Manual control:	button PROG (ON/OFF)
External button / switch:	yes
Other data	
Operating temperature:	-15 to +45 °C
Working position:	any
Mounting:	free at lead-in wires
Protection:	IP40
Overvoltage category:	III.
Contamination degree:	2
Connection:	screwless terminals
Connecting conductor:	0.2-1.5 mm ² solid/flexible
Dimensions:	43 x 44 x 22 mm
Weight:	30 g
Related standards:	EN 60730, EN 63044, EN 301489, EN 300328

The given value is for load R, see table p. 70

Types of connectable loads

R resistive	L inductive	C capacitive	ESL light bulbs	LED light bulbs

- Universal built-in dimmer is used to regulate light sources:
 - R – classic light bulbs,
 - L – halogen bulbs with wound transformer,
 - C – halogen bulbs with electronic transformer,
 - ESL – dimmable energy saving lamps,
 - LED – LED light sources (230 V).
- The Thread protocol guarantees compatibility with other products with the Matter support.
- Control input "S" for connection of the existing wired pushbutton.
- The programming pushbutton on the element can also be used as manual control of the output.
- The applicable reach is up to 200m (in free area).
- The BOX design offers installation directly in the junction box, soffit or cover of the light fitting.
- The element with the controller can be paired through a border router supporting Matter and through an application supporting Matter. The border router is understood as equipment such as HomePod Mini, Google Nest Hub or Samsung SmartThings Station.

Device description

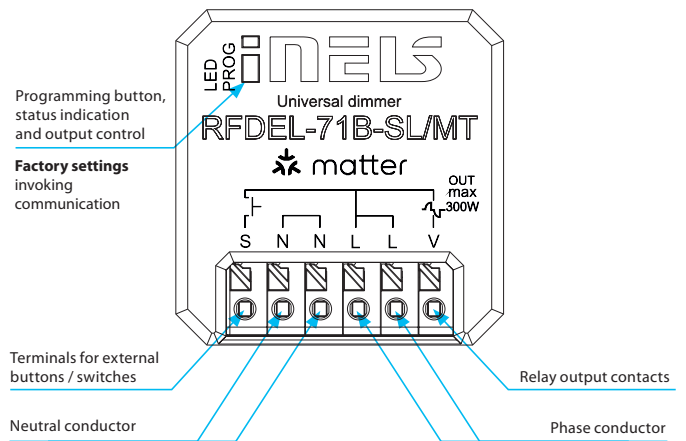

Connection

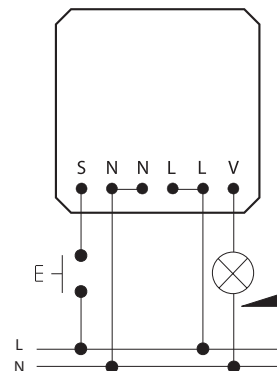



EAN code:
RFMD-200: 8595188191302

Technical parameters	RFMD-200/MT
Power supply:	2x 1.5 V AA batteries
Battery life:	up to 1 year, according to the number of activations
Drained battery indicator:	yes
Control	
Application protokol:	Matter
Communication protokol:	THREAD
Frequency:	2,4 GHz
Repeater function:	no
Detection angle:	110°
Detection distance:	max. 9.5 m
Recommended working height:	max. 2.5 m
Other data	
Working temperature:	-10 to +50 °C
Protection:	IP20
Colour:	white
Dimension:	ø 95mm, height incl. lens 30mm
Weight:	113 g
Related standards:	EN 60730, EN 63044, EN 301489, EN 300 328

- The motion detector PIR is used to detect presence persons moving inside the building interior
- The Thread protocol guarantees compatibility with other products with the Matter support.
- Use:
 - in combination with a switching unit for automatic control of lighting or triggering an alarm
 - through the boarder router Matter, the detection can be displayed on your smartphone in the form of a notification
- Sensitivity settings of the PIR detector for eliminating unwanted triggering
- Power supply: 2x 1.5 V AA batteries, the battery life is around 1 year
- "Low Battery" Alerts by double LED flashing or on Matter app
- The Unit with the controller can be paired through a border router supporting Matter and through an application supporting Matter. The border router is understood as equipment such as HomePod Mini, Google Nest Hub or Samsung SmartThings Station.

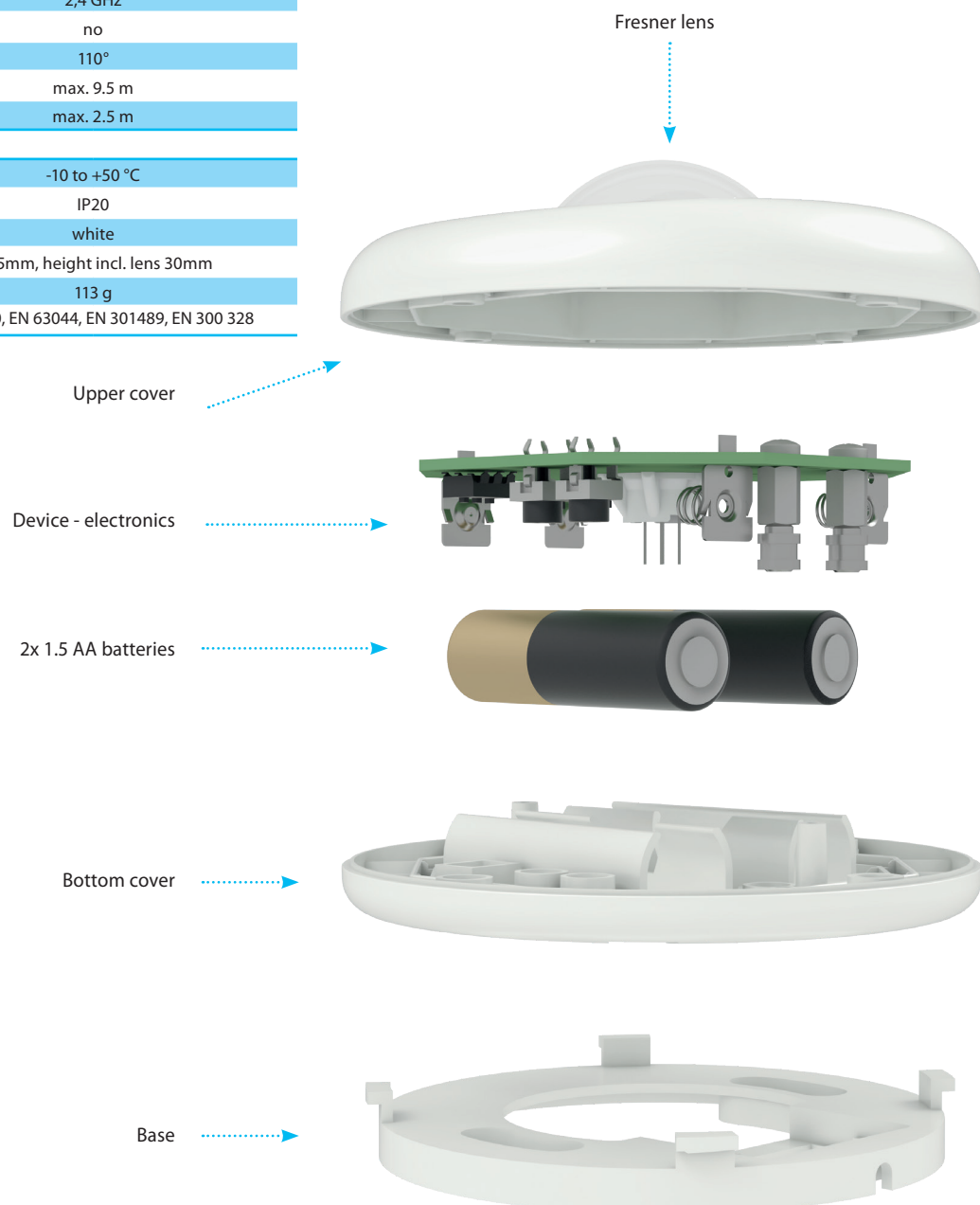



EAN code:
RFMD-100: 8595188189538

Technical parameters	RFWD-100/MT
Power supply:	1x 3 V CR 2032 battery
Battery life:	up to 1 year, according to the number of activations
Drained battery indicator:	yes
Control	
Application protocol:	Matter
Communication protocol:	THREAD
Frequency:	2,4 GHz
Detection angle:	105°
Other data	
Working temperature:	-10 to +50 °C
Protection:	IP20
Colour:	white
Dimension:	25 x 75 x 16 mm
Magnet dimension:	15 x 75 x 14 mm
Standards:	EN 60730, EN 63044, EN 301489, EN 300328

- The Window/Door detector is used to detect opening where activation occurs when the magnet and the sensor become separated
- It communicates on the Thread protocol that guarantees compatibility with other products with the Matter support
- Use:
 - in combination with the switching unit for automatic light control (cellar, garage, etc.)
 - by means of the Matter application, detection can be displayed on your smart phone in the form of a notification
- Power supply: 1x 3 V CR 2032 battery, the battery life is around 1 year
- Display of battery percentage in the form of Matter Application
- The pairing of the detector with the element is done via a border router supporting Matter and via a Matter-enabled application. Border router means a device such as a HomePod Mini, Google Nest Hub or Samsung SmartThings Station.



A series of horizontal blue lines spaced evenly down the page, providing a template for writing.

Hotel Room Energy Saving Kit (HRESK)

Cost savings, increased comfort,
introduction of automation into a hotel room

hresk

N

2023

RFGS-30/SW
(WHITE glass, SHARP)

- In connection with the RFSW-xx/S room unit (or RFTC-3 thermostat), it is used to signal the status of MUR (green LED) and DND (red LED)
- Also includes button for controlling a room bell connected to the switched output of this unit or any iNELS Wireless switching element. The button bell has 2 colors of backlighting (explained below)
- The second switched output of this unit can be used to switch the in front door light and control it from the schedule HRS system, by time or ambient light intensity
- The unit can be mounted in an installation box, for example replace the original bell button or light switch, only requires a 230V AC or AC/DC 24 V power supply. Communication is then wireless
- The unit can be controlled by up to 4 rooms units (RFSW-xx/S or RFTC-3)
- Setup and programming is done by a pairing button + signaled by service LEDs
- The unit can be connected to the HRS (Hotel Reception Software) via the eLAN-RF gateway or the RFTC-3 thermostat. The functions can then be controlled from the reception PC console or the iNELS application.
- Standard glass colour white/black, room number and hotel logo can be defined when ordering
- Available with AC 230V or AC/DC 24V power supply with the option of galvanically isolated relay output contacts from the power supply (see table on the next page and connection below)

Technical parameters

RFGS-30/S

Supply voltage:	230 V AC / 50-60 Hz	24 V AC / DC
Apparent/loss power input:	1.2 VA/0.6 W	0.6 VA/0.6 W
Supply voltage tolerance:	±10 %	

Output

Relays capacity:	2x switching / 8 A / 250 V AC1 / 2000 VA / ZERO CROSS
Peak Current:	$I_{peak} < 110A$ 300us / max. input capacitance 125 uF
Contact Life:	mechanical 10 mil. / electrical 100,000 cycles

Control

Control items:	1 button / 1DND / 1MUR
Communication:	wireless, iNELS RFIO2 protocol
Frequency:	866-922 MHz (more on page 85)
Repeater Function:	yes
Range:	in open areas up to 200 m

Connection

Terminal block:	screwless - push in
Wire gauge:	0.2 - 1.5 mm ² solid flexible

Other data

Operating Temperature:	-10 to +50 °C
Storage temperature:	-30 to +70 °C
Protection degree:	front IP60 / rear IP20
Overvoltage Category:	II.
Pollution Degree:	2
Working position:	Any
Installation:	flush mount to the installation box, BS or EU standard
Dimension:	Sharp: 94 x 94 x 39 mm / Round: 100 x 100 x 39 mm
Weight:	Sharp: 131 g / Round: 138 g
Related standards:	EN 60730, EN 63044, EN 301489, EN 300 220

Instrument description

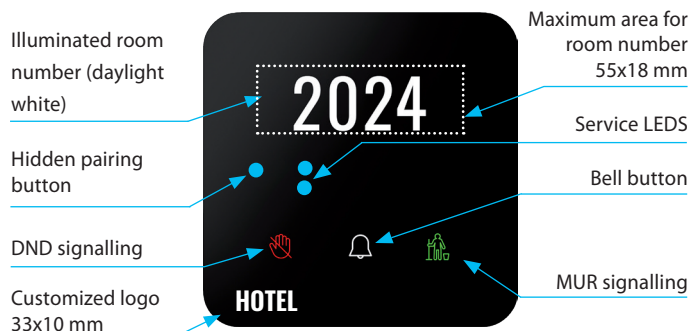
RFGS-230/SB
(BLACK glass, ROUND)

EU standard

British standard

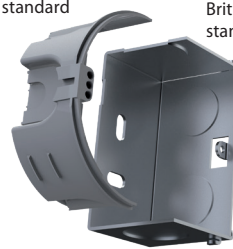

Installation box

Metal holder

Device



Output relays are equipped with ZERO CROSS technology, which allows switching the load when the voltage passes zero, i.e. in the minimum current consumption, which prevents burning and sticking of relay contacts - especially when switching electronic ballasts, which are part of each LED luminaire.

Connection

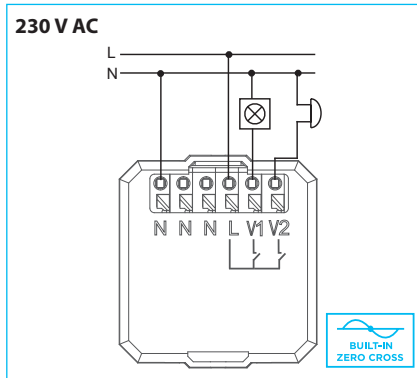

The output contacts (V1, V2) switch the phase potential (L) and are equipped with **zero cross** switching technology.

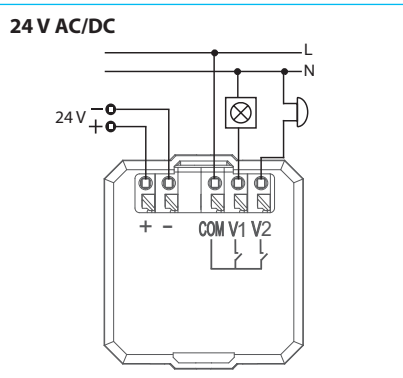

The output contacts (V1, V2) are galvanically isolated from the power supply and share a common COM terminal.

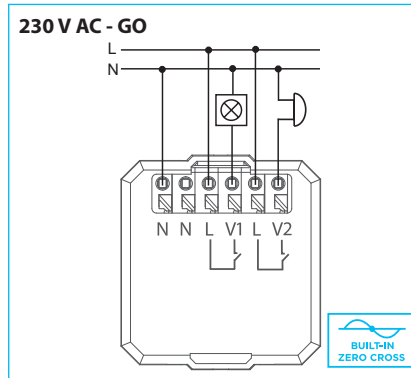

Output contact V1 is at the same potential as the product power supply. Output contact V2 is separate from the power supply but must be connected to the same potential. The wiring is used when it is necessary to secure V1 and V2 separately.



RFGS-230/SW
(WHITE glass, ROUND)

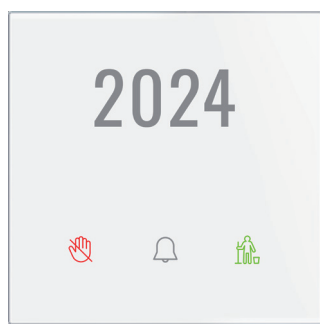

RFGS-30/SW
(WHITE glass, SHARP)



RFGS-230/SB
(BLACK glass, ROUND)

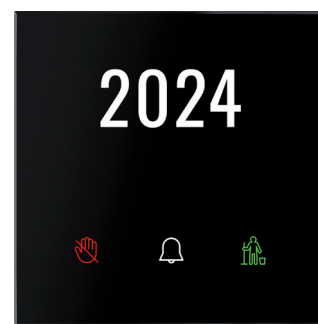

RFGS-30/SB
(BLACK glass, SHARP)

Button legend

MUR GREEN backlight
Make Up Room

DND RED backlight
Do not Disturb

Backlighting see table
Bell

BELL button backlight meaning

Symbol	Colour	Room	Ring
	White	vacant	YES
	Blue	occupied	YES
	Blue+DND active	occupied, but „Do not disturb“	NO

Icons are illustrative - configure your own look using the configurator:
icons.inels.com



Type	Number of buttons	Design ROUND SHARP	Glass colour	Power supply	Galvanically isolated output contact	EAN	Code
RFGS-30/SW/230V	1	S	White	AC 230 V	–	8595188189477	8947
RFGS-230/SW/230V	1	R	White	AC 230 V	–	8595188192712	9271
RFGS-30/SB/230V	1	S	Black	AC 230 V	–	8595188189200	8920
RFGS-230/SB/230V	1	R	Black	AC 230 V	–	8595188192705	9270
RFGS-30/SW/24V	1	S	White	AC/DC 24 V	✓	8595188191586	9158
RFGS-230/SW/24V	1	R	White	AC/DC 24 V	✓	8595188192736	9273
RFGS-30/SB/24V	1	S	Black	AC/DC 24 V	✓	8595188191579	9157
RFGS-230/SB/24V	1	R	Black	AC/DC 24 V	✓	8595188192729	9272
RFGS-30/SWGO/230V	1	S	White	AC 230 V	✓	8595188192675	9267
RFGS-230/SWGO/230V	1	R	White	AC 230 V	✓	8595188192699	9269
RFGS-30/SBGO/230V	1	S	Black	AC 230 V	✓	8595188192668	9266
RFGS-230/SBGO/230V	1	R	Black	AC 230 V	✓	8595188192682	9268

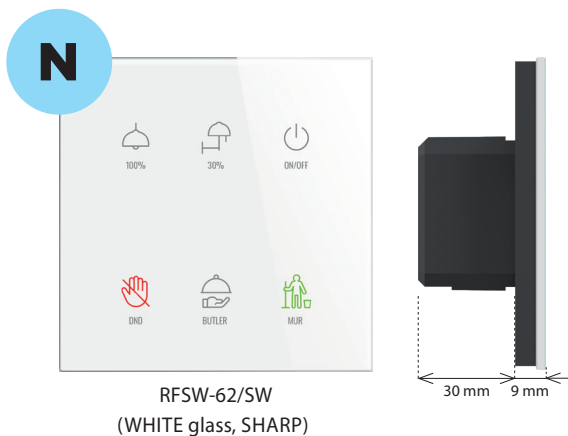

- The wireless glass remote control with symbols is used for:
 - Control of iNELS Wireless elements
 - MUR/DND control of RFGS-30/S front door unit
 - Switching of 2x light circuits by built-in relays
- MUR (Make Up Room, green LED) and DND (Do not Disturb, red LED) buttons are interlocked
- Butler button calls hotel service (set in HRS)
- The top buttons can be freely defined to control local outputs of the unit or any iNELS Wireless element located in the room (switching, dimming, shading)
- Setup and programming is done by pairing button + signaling by service LEDs
- The unit can be connected to the HRS (Hotel Reception Software) system via eLAN-RF gateway or RFTC-3 thermostat. The functions can then be controlled from the reception PC console or the iNELS application of the phone.
- Standard glass colour white/black, buttons and descriptions at the top - or hotel logo when ordering
- Available with AC 230V or AC/DC 24V power supply with the option of galvanically isolated relay output contacts from the power supply (see table on the next page and connection below)

Technical parameters

RFSW-xx/S

Supply voltage:	230 V AC / 50-60 Hz	24 V AC/DC
Apparent/loss power input:	1.2 VA/0.6 W	0.6 VA/0.6 W
Supply voltage tolerance:	±10 %	

Output

Relay:	2x switching / 8 A / 250 V AC1 / 2000 VA / ZERO CROSS
Peak Current:	I _{peak} < 110A 300us / max. input capacitance 125 uF
Contact Life:	mechanical 10 mil. / electrical 100,000 cycles

Control

Control items:	2 or 4 buttons / 1DND / 1MUR
Communication:	wireless, RFIO2 iNELS protocol
Frequency:	866-922 MHz (more on page 85)
Repeater Function:	yes
Range:	in open areas up to 200 m

Connection

Terminal block:	screwless - push in
Wire gauge:	0.2 - 1.5 mm ² solid flexible

Other data

Operating Temperature:	-10 to +50 °C
Storage temperature:	-30 to +70 °C
Protection degree:	front IP60 / rear IP20
Overvoltage Category:	II.
Pollution Degree:	2
Working position:	Any
Installation:	flush mount to the installation box, BS or EU standard
Dimension:	Sharp: 94 x 94 x 39 mm / Round: 100 x 100 x 39 mm
Weight:	Sharp: 131 g / Round: 138 g
Related standards:	EN 60730, EN 63044, EN 301489, EN 300 220

Device description- Capital letters in brackets indicate the position of the buttons

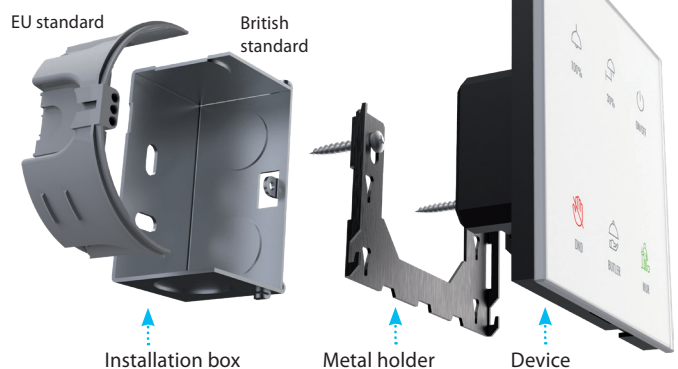
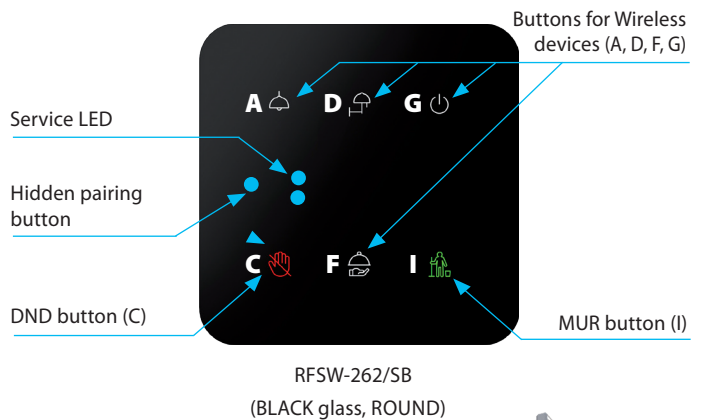

Output relays are equipped with ZERO CROSS technology, which allows switching the load when the voltage passes zero, i.e. in the minimum current consumption, which prevents burning and sticking of relay contacts - especially when switching electronic ballasts, which are part of each LED luminaire.

Connection

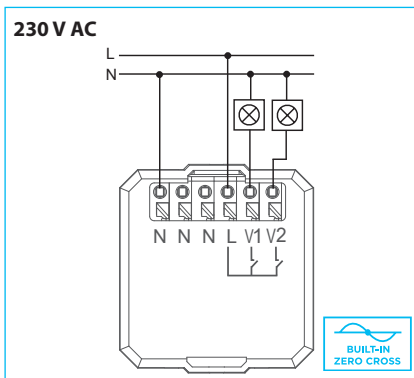

The output contacts (V1, V2) switch the phase potential (L) and are equipped with **zero cross** switching technology.

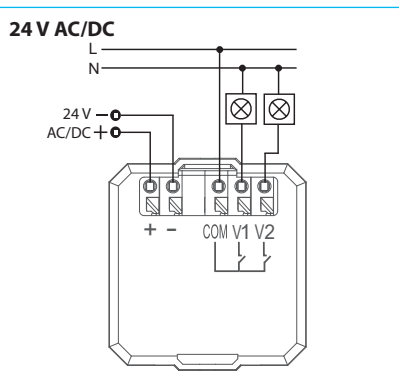

The output contacts (V1, V2) are galvanically isolated from the power supply and share a common COM terminal.

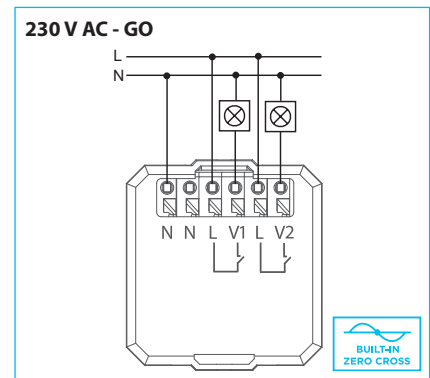

Output contact V1 is at the same potential as the product power supply. Output contact V2 is separate from the power supply but must be connected to the same potential. The wiring is used when it is necessary to secure V1 and V2 separately.

Button positions **C** and **I** are always reserved for controlling DND (red), MUR (green LED) and are mutually interlocked. Other button positions (**A, D, F, G**) are freely configurable for controlling local outputs or optional iNELS Wireless actuators.

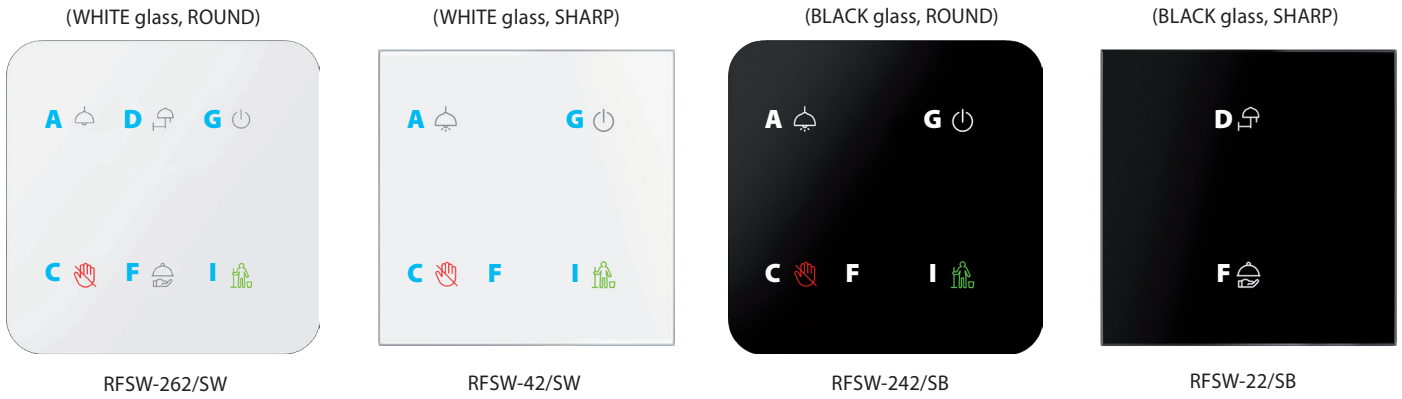

Legend of buttons:



Icons are illustrative - configure your own look using the configurator: icons.inels.com

Type	Number of buttons	Design ROUND SHARP	Glass colour	Power supply	Galvanically isolated output contact	EAN	Code
RFSW-22/SW/230V	2	S	White	AC 230 V	-	8595188194310	9431
RFSW-42/SW/230V	4	S	White	AC 230 V	-	8595188194198	9419
RFSW-62/SW/230V	6	S	White	AC 230 V	-	8595188193863	9386
RFSW-222/SW/230V	2	R	White	AC 230 V	-	8595188194334	9433
RFSW-242/SW/230V	4	R	White	AC 230 V	-	8595188194211	9421
RFSW-262/SW/230V	6	R	White	AC 230 V	-	8595188193948	9394
RFSW-22/SB/230 V	2	S	Black	AC 230 V	-	8595188194303	9430
RFSW-42/SB/230V	4	S	Black	AC 230 V	-	8595188194181	9418
RFSW-62/SB/230V	6	S	Black	AC 230 V	-	8595188193856	9385
RFSW-222/SB/230V	2	R	Black	AC 230 V	-	8595188194327	9432
RFSW-242/SB/230V	4	R	Black	AC 230 V	-	8595188194204	9420
RFSW-262/SB/230V	6	R	Black	AC 230 V	-	8595188193931	9393
RFSW-22/SW/24V	2	S	White	AC/DC 24 V	✓	8595188194396	9439
RFSW-42/SW/24V	4	S	White	AC/DC 24 V	✓	8595188194273	9427
RFSW-62/SW/24V	6	S	White	AC/DC 24 V	✓	8595188193887	9388
RFSW-222/SW/24V	2	R	White	AC/DC 24 V	✓	8595188194419	9441
RFSW-242/SW/24V	4	R	White	AC/DC 24 V	✓	8595188194297	9429
RFSW-262/SW/24V	6	R	White	AC/DC 24 V	✓	8595188193962	9396
RFSW-22/SB/24V	2	S	Black	AC/DC 24 V	✓	8595188194389	9438
RFSW-42/SB/24V	4	S	Black	AC/DC 24 V	✓	8595188194266	9426
RFSW-62/SB/24V	6	S	Black	AC/DC 24 V	✓	8595188193870	9387
RFSW-222/SB/24V	2	R	Black	AC/DC 24 V	✓	8595188194402	9440
RFSW-242/SB/24V	4	R	Black	AC/DC 24 V	✓	8595188194280	9428
RFSW-262/SB/24V	6	R	Black	AC/DC 24 V	✓	8595188193955	9395
RFSW/22/SWGO/230V	2	S	White	AC 230 V	✓	8595188194358	9435
RFSW/42/SWGO/230V	4	S	White	AC 230 V	✓	8595188194235	9423
RFSW-62/SWGO/230V	6	S	White	AC 230 V	✓	8595188193900	9390
RFSW-222/SWGO/230V	2	R	White	AC 230 V	✓	8595188194372	9437
RFSW-242/SWGO/230V	4	R	White	AC 230 V	✓	8595188194259	9425
RFSW-262/SWGO/230V	6	R	White	AC 230 V	✓	8595188193924	9392
RFSW-22/SBGO/230V	2	S	Black	AC 230 V	✓	8595188194341	9434
RFSW-42/SBGO/230V	4	S	Black	AC 230 V	✓	8595188194228	9422
RFSW-62/SBGO/230V	6	S	Black	AC 230 V	✓	8595188193894	9389
RFSW-222/SBGO/230V	2	R	Black	AC 230 V	✓	8595188194365	9436
RFSW-242/SBGO/230V	4	R	Black	AC 230 V	✓	8595188194242	9424
RFSW-262/SBGO/230V	6	R	Black	AC 230 V	✓	8595188199917	9391



EAN code:
RFSA-266M: 8595188189781

Technical parameters		RFSA-266M/230V
Supply voltage:		110–230 V AC
Supply voltage frequency:		50–60 Hz
Apparent input:		min. 2 VA/max. 5 VA
Dissipated power:		min. 0.5 W/max. 2.5 W
Supply voltage tolerance:		+10%/-25 %
Output		
Number of contacts:		5x switching (AgSnO ₂) / 7 A/AC1 / 10 A/<3 s
Switching power:		1750 VA/AC1
Switching voltage:		250 V AC1
Mech. / el. service life (AC1):		5x 10 ⁶ / 6x10 ⁴
Analog output		2x 0 – 10V (OUT1, OUT2)
Input		
Analog		YES, 2x terminals INT1/GND, INT2/GND / 2x NTC 12 ICR (TC/TZ sensor)
Control		
Communication protocol:		RFIO2, MODBUS, WIFI, MQTT
Frequency:		866–922 MHz (for more info see p. 85)
Repeater function:		yes
Range:		in open space up to 160 m - RFSA-66MI
Other data		
Operating temperature:		-15 °C to +50 °C
Operating position:		any
Mounting:		DIN rail EN 60715
Protection:		IP20 from the front panel
Overvoltage category:		III.
Contamination degree:		2
Connecting conductor cross-section (mm ²):		max. 1x 2.5, max. 2x 1.5/ with a hollow max. 1x 2.5
Dimensions:		90 x 52 x 65 mm
Weight:		264 g
Related standards:		EN 60730, EN 63044, EN 300 220, EN 301 489

- Thanks to the 5-channel design of the switching component it can control the heating/cooling mode and 3 speed levels.
- The RFSA-266M wireless switch unit can be combined with the RFTC-4.
- The input channels are used to connect to external TC/TZ temperature sensor.
- The product is independently functional when connected to the MODBUS, otherwise it must be connected to control element, e.g. RFTC-4.
- Support for both 2-pipe fancoil and 4-pipe fancoil.
- Fancoil controls the cooling or heating of the room and provides up to 3 speed levels.
- In case of insufficient signal between the controller and the switch unit, use the signal repeater RFRP-20N or elements with RFIO2 protocol that support this function.

Connection for fancoil control

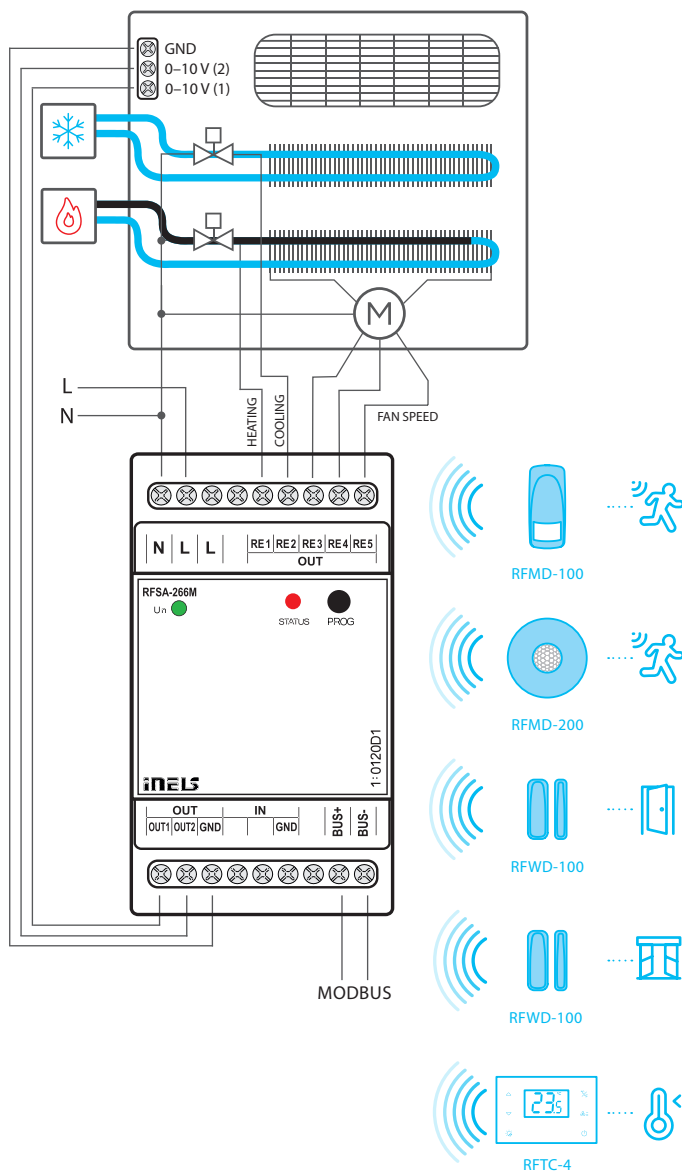



EAN code:
RFSTI-111B: 8595188149150

Technical parameters	RFSTI-111B/230V	RFSTI-111B/120V
Supply voltage:	230 V AC	120 V AC
Supply voltage frequency:	50–60 Hz	60 Hz
Apparent input:	9 VA/cos φ= 0.1	9 VA/cos φ= 0.1.
Dissipated power:	0.7 W	
Supply voltage tolerance:	+10 %; -15 %	
Temperature measurement input:	1x external TZ/TC temperature sensor input	
Temp. measurement range and accuracy:	+15 to +35 °C; 0.5 °C of the range	
Output		
Number of contacts:	1x switching (AgSnO ²)	
Rated current:	12 A/AC1	
Switching power:	3000 VA/AC1, 288 W/DC	
Peak current:	30 A/max. 4 s at 10%	
Switching voltage:	250 V AC1/24 V DC	
Min. switching power:	100 mA/10 V	
Insulation voltage between relay outputs and internal circuits:	basic insulation (Cat. III surges by EN 60664-1)	
Isolates. voltage open relay contact:	1 kV	
Mechanical service life:	3x10 ⁷	
Electrical service life (AC1):	5x10 ⁴	
Control		
Communication protocol:	RFIO2	
Frequency:	866–922 MHz (for more information see p. 85)	
Repeater function:	yes	
Range:	in open space up to 160 m	
Other data		
Operating temperature:	-15 to +50 °C	
Storage temperature:	-30 to +70 °C	
Indication of relay switch:	red LED	
Indication regulation:	green LED	
Operating position:	any	
Mounting:	free at lead-in wires	
Protection:	IP30	
Overvoltage category:	III.	
Contamination degree:	2	
Outlets (CY wire, cross-section, length):	2 x 0.75 mm ² , 2 x 2.5 mm ² , 90 mm	
Dimensions:	49 x 49 x 21 mm	
Weight:	50 g	
Related standards:	EN 60730, EN 63044, EN 301489, EN 300 220	

Temperature sensor input is at the supply voltage potential.

- The component measures temperature in the range of 15 to 35 °C with external sensor and on the basis of the set temperature switches air conditioning.
- It is particularly suitable for hotel rooms.
- With the Window/Door sensor programmed, when the window/door is opened, the device relay contact is automatically disconnected, there by saving unnecessary energy consumed for cooling when the window/door is open.
- It enables connection of the switched load up to 12 A (3000 VA).
- Up to 4 RFWD-100 detectors can be connected to one RFSTI-111B device.
- Range up to 160 m (in open space), if the signal is insufficient between the controller and unit, use the signal repeater RFRP-20N or protocol component RFIO2 that support this feature.
- The BOX design lets you mount it right in an installation box, a ceiling or controlled appliance cover.
- External sensor TC (-20 to +80 °C) or TZ (-40 to +125 °C) for length of 3 m, 6 m, 12 m. For more information see „Accessories“ on page 45.

Device description

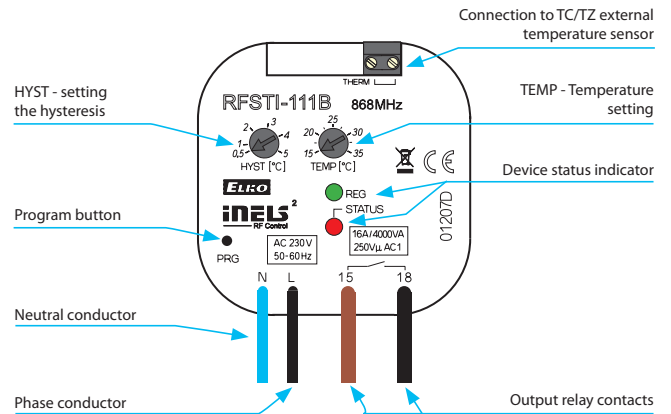

Function

The external sensor senses the temperature of the room, turns the air conditioner on and off according to the set temperature. Responds to commands from the detector - when you open the window, turn off air conditioning.

Connection

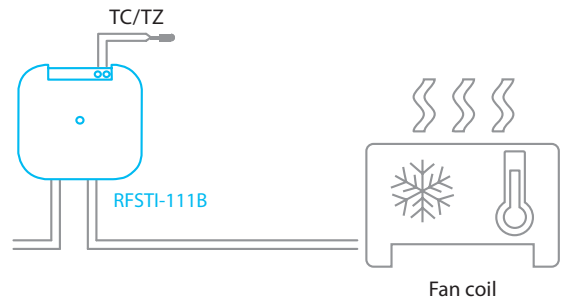



A series of horizontal blue lines spaced evenly down the page, providing a template for writing.

AN-I | Internal antenna



EAN code:
AN-I: 8595188161862

Technical parameters	AN-I
Polarization:	vertical
Gain:	2.1 dBi
Dimensions:	17 x 44 x 8.5 mm
Impedance:	50 Ω
Colour:	black

The rod antenna with SMA connector is supplied as standard with the product.

AN-I antenna measurement graph

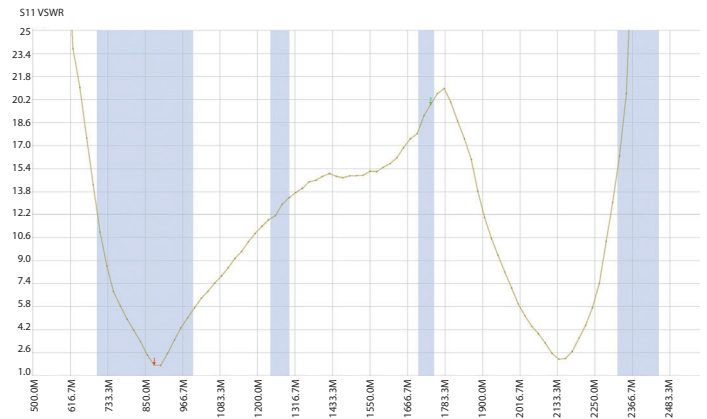

- The internal antenna is included in the standard package.

Extension cable for external antenna



10 m

Technical parameters	
Connector Type:	SMA (male/female)
Colour:	white
Cable Length:	10 m

Measured range between controllers and RFSA-66M

	RFGB	RFWB	RF KEY
AN-I	305 m	290 m	190 m
AN-E	300 m	290 m	200 m
AN-E3	275 m	260 m	180 m

The range is measured with direct visibility between the RFGB-x, RFWB-x, RF KEY and RFSA-66M actuators.

Connecting the antenna extension cable does not affect the range.

RFAF/USB | Service Key

Technical parameters	RFAF/USB
Power:	max. 1 W
Interface:	USB 1.1 and higher, plug. „A“
Range:	100 m
Min. distance of RF Touch-Actuator:	1 m
Communication protocol:	RFIO2
Frequency:	866–922 MHz (for more information see p. 85)
Power supply indication:	green LED
communication indication:	red LED
Other data	
Operating temperature:	0 to +55 °C
Storage temperature:	- 20 to +70 °C
Protection:	IP30
Contamination degree:	2
Work space:	any
Installation:	any
Dimensions:	22 x 85 x 15 mm
Weight:	20 g
Related standards:	EN 60730, EN 63044, EN 300 220, EN 301 489



EAN code:
RFAF/USB: 8595188145039

- The RFAF/USB Service Key (in conjunction with the Wireless_analyzer) is designed for iNELS Wireless Control system partners and serves for:
 - Setting the repeater (signal amplifier) through the iNELS Wireless Control elements labeled as RFIO2. This option allows you to communicate over longer distances (in the order of 50 m) via existing iNELS Wireless elements in the installation (eliminating the use of the RFRP-20N repeater).
 - upgrade of firmware in the iNELS Wireless elements (labeled RFIO2), in the case of new firmware versions that improve the functionality of the elements on which we are constantly working.
 - The Wireless Network Analyzer will reliably analyze the communication between the controller (where you plan to place it) and the component in the installation. Indicates signal strength/quality as well as possible frequencies that can interfere with communication.
 - SW Wireless analyzer can be found at inels.com/partners in section SW/FW Wireless Control

AN-E1 | External antenna



EAN code:
AN-E1: 8595188190121

Technical parameters	AN-E1
Mounting:	Magnetic Mount
Cable Length:	3 m
Polarization:	vertical
Gain:	5 dBi
Impedance:	50 Ω
Colour:	black
Dimensions:	Ø 30 x 280 mm

AN-E antenna measurement graph

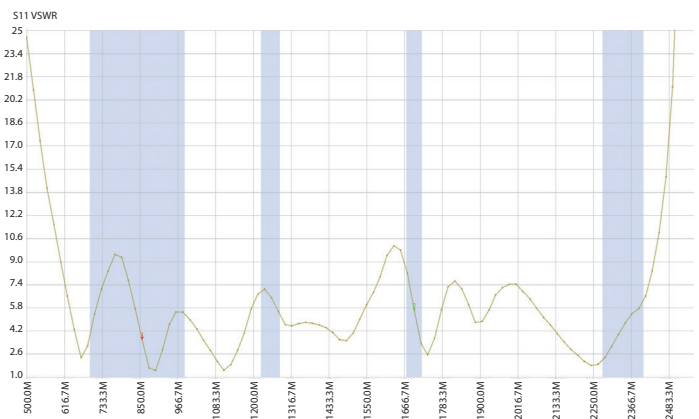

AN-E3 | External antenna



EAN code:
AN-E3: 8595188190121

Technical parameters	AN-E3
Cable Length:	3 m
Polarization:	vertical
Gain:	3 dBi
Impedance:	50 Ω
Colour:	black
Dimensions:	Ø 50 x 88 mm

AN-E3 antenna measurement graph

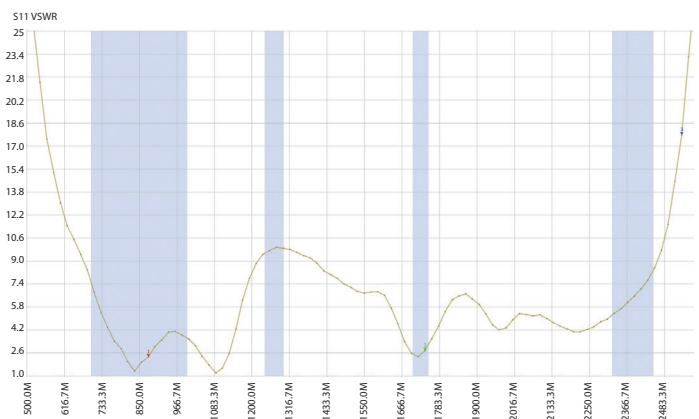

- The external antenna is intended for outdoor use.

MS | Magnetic sensor

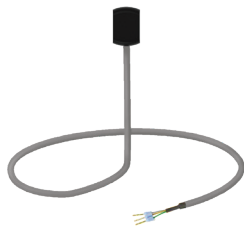

- The LED sensor scans LED impulses on the meter, which indicates consumption by flashing.
- The LED sensor is particularly suitable for power meters that support LED pulse sensing (the LED on the meter is marked "imp").
- The sensor's scanner is affixed with glue above the LED diode of the meter signaling indication of consumption.
- The sensor is connected to the internal terminal of the RFTM-1 converter.

Technical parameters	MS
Voltage range:	1.6 to 3.6 V
Consumption	7uA *
Output load:	max. 3mA
Scanning period:	100ms
Switch sensing sensitivity (output L):	±(2.3 to 4.7)mT
Opening detection sensitivity (output->H):	±(0.9 to 3.8)mT
Hysteresis:	1mT
Working temperature:	-40 to 80 °C
Other data	
Cross-section of connecting wires:	max. 3.5 mm
Wire length:	1.5 m
Protection:	IP20

LS | LED sensor

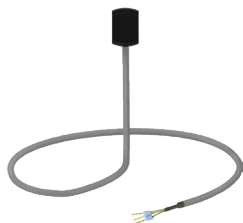

- The LED sensor scans LED impulses on the meter, which indicates consumption by flashing.
- The LED sensor is particularly suitable for power meters that support LED pulse sensing (the LED on the meter is marked "imp").
- The sensor's scanner is affixed with glue above the LED diode of the meter signaling indication of consumption.
- The sensor is connected to the internal terminal of the RFTM-1 converter.

Technical parameters	LS
Voltage range:	2.5 to 3.7V
Minimum consumption (idle mode):	0.5uA *
Maximum power consumption (pulses 100Hz):	max. 2uA *
Working temperature:	-20 to 50 °C
Other data	
Cross-section of connecting wires:	max. 3.5 mm
Wire length:	1.5 m
Protection:	IP20

Sensor LS responds only to light pulses, i.e. it does not detect static state LEDs.

WS | Magnetic sensor for water meter

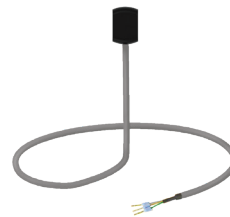

- A magnetic sensor that detects the pulse that is created by each rotation of the magnet placed on the unit dial meter.
- The WS sensor is especially suitable for water meters that support magnetic sensing.
- The sensing sensor is glued over the circular unit face of the gauge (the scanning dial is different from the other indicators, e.g. the white arrow wheel).
- The sensor is connected to the internal terminal of the RFTM-1 converter.

Technical parameters	WS
Voltage range:	1.65 to 5.5V
Consumption:	1.5uA *
Output load:	max. 150uA
Switch sensing sensitivity:	±(0.3 to 1.1)mT
Opening detection sensitivity:	±(0.2 to 0.9)mT
Hysteresis:	0.2mT
Working temperature:	-40 to 80 °C
Other data	
Cross-section of connecting wires:	max. 3.5 mm
Wire length:	1.5 m
Protection:	IP20

* Measured at 3V, no load output.

Smartphones



- Control application for smartphones and tablets with Android and iPhone operating systems - iHC-AiO. It allows you to easily control your house.
- The user-friendly and intuitive application environment offers central control from one place.
- The application enables control of the complete iNELS Wireless and BUS solution via the Smart RF gate, Connection server, Central unit and other supported third-party devices that are connected to the home Internet network.
- The application allows free remote control.
- IHC-AiO features:
 - unification of all iNELS devices under one application. Specifically, eLAN RF 003, eLAN RF 103, eLAN IR, CU3, CS and LARA
 - within BUS it is now possible to configure rooms without the need for a public server or CS
 - user management - in the application it will be possible to set rights for all users who will use one system
 - automation - creation of conditions within Wireless, BUS systems or in both systems
 - low battery notification, alarms, actuator status
 - history of states of individual actors
 - display of all added devices in a clear menu and the possibility of configuring your own dashboard.

Manual:

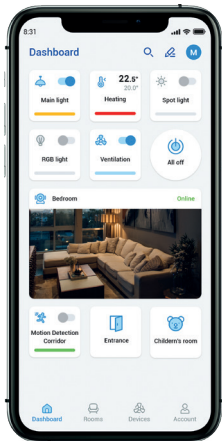

Overview

Absolute control over the state of all technologies.

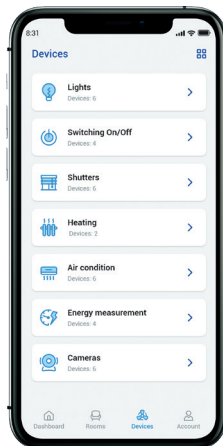

Device list

Control the device from anywhere.

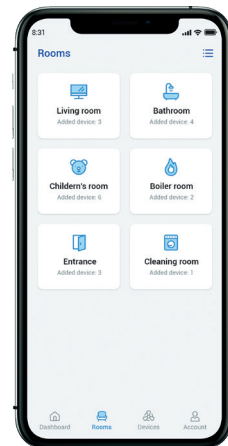

Rooms management

Settings according to individual rooms.

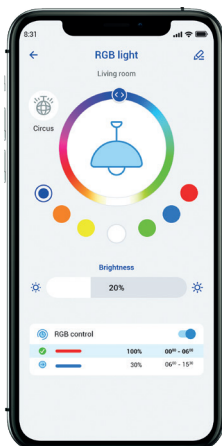

Colour setting

Easy adjustment of the light scene with one touch - switching, dimming, colour.

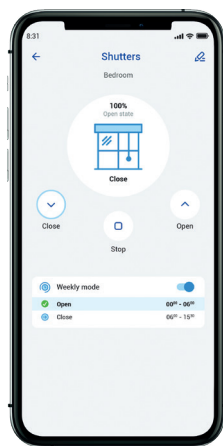

Shutters/Blinds

Possibility of individual or joint control of shading technology.



Temperature

You can set the temperature in each room exactly as you like.

Smart TV



- Device control via Smart TV is possible not only in the wireless installation of iNELS Wireless Control using the smart box eLAN-RF, but also in the case of wired option iNELS BUS using the Connection server. The iHC-SMTV app is free to download from the app store on your Smart TV.
- The control of app works with a classic TV remote control.
- Every Smart TV that has been manufactured since 2015 and supports OS Tizen is compatible.
- Functionality:
 - ON/OFF switching, with the possibility of time schedules
 - dimming ON/OFF, smooth brightening/dimming, color change
 - scenes
 - heating (temperature correction, heating mode change, cooling/heating mode)
 - cameras (image, or live stream if supported by web browser on Smart TV).
- iHC-SMTV (Smart TV App) is free and is not licensed in any way.
- Here you will find a link to the application:

Download:

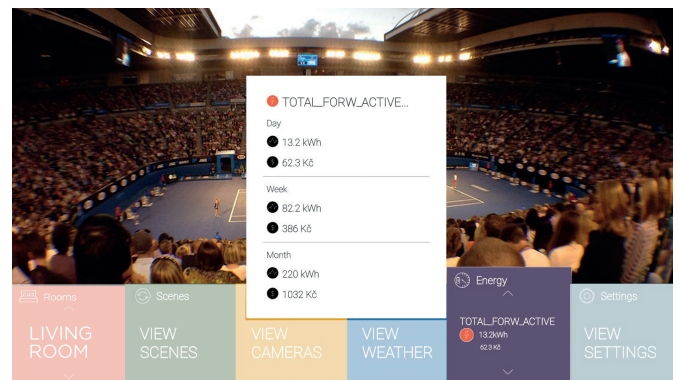
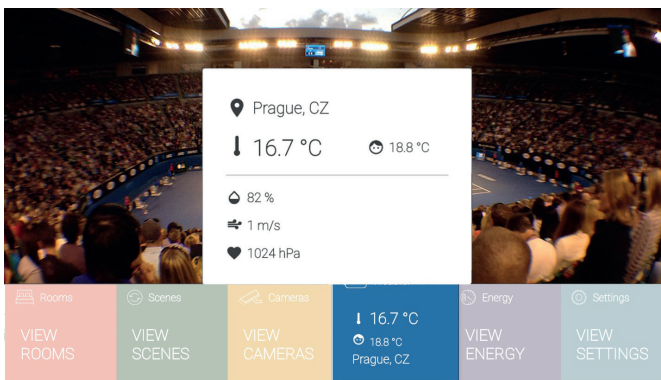
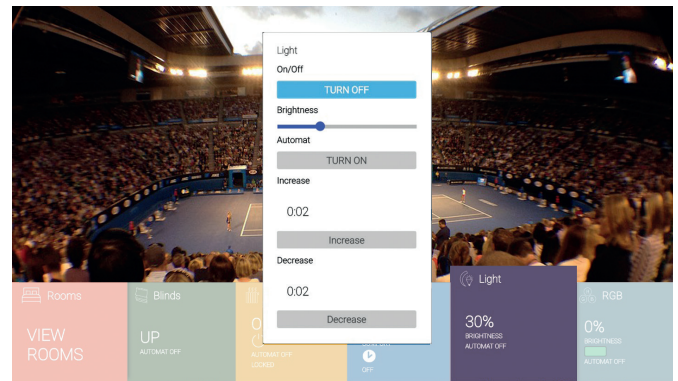
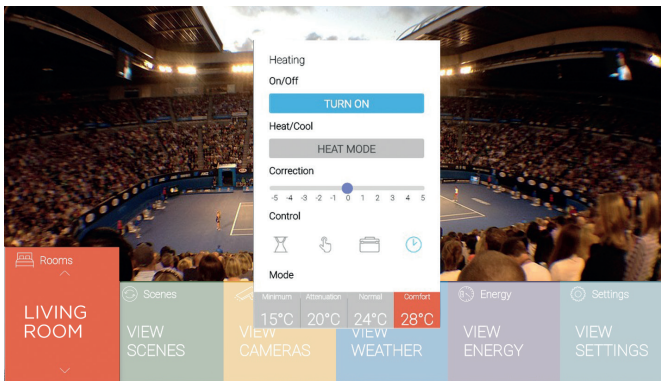
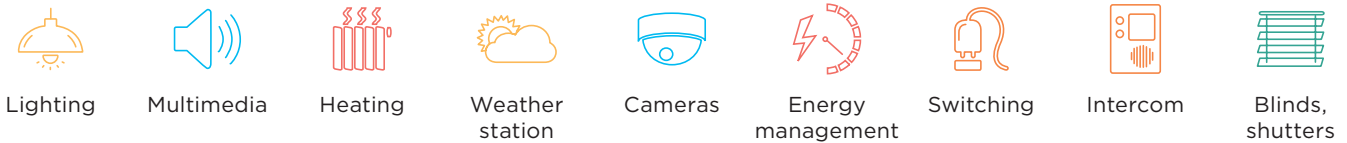

Amazon Alexa



- With Alexa Artificial Intelligence, you can simplify your daily life by setting an alarm, notifications, creating new items, or reminders in your calendar.
- The voice assistant can answer questions and control individual devices and smart homes.
- It is available on mobile phones, TVs, smart speakers and other devices.
- The voice assistant is designed to comfortably control the Wireless Control wiring by voice using your mobile phone or smart speaker.
- As a complement to Wireless Control, iNELS Smart Home Solution blends in with every modern home.
- Here you will find a link to the manual:



EN

Google Home



- Google Home can become a member of your smart home family.
- It communicates with the smart eLAN-RF box via the Cloud connection.
- This allows you to control, for example, the temperature setting or the light intensity by voice.
- The voice assistant is designed to conveniently control the Wireless Controlled electro-installations by voice using your mobile phone or smart speaker.
- As a complement to Wireless Control, iNELS Smart Home Solution blends in with every modern home.
- Here you will find a link to the manual:



EN



New mobile app for controlling all compatible elements from the iNELS portfolio.

Application iNELS:

- Designed for iOS 11+ and Android 7.0+.
- Optimized for devices with 1 024 x 768 screen resolution.
- The language of the application changes automatically according to the language set in Android/iOS.
- You can create a cloud account on the login screen in the app. The recommended minimum speed for connecting the eLAN-RF to the Cloud should be in the order of megabytes per second (3G - 1Mbit/s and higher).

The communication between the components is wireless at 866–922 MHz (according to country standards/regulations), using the unique RFIO and RFIO2 protocols. Both are proprietary wireless protocols from ELKO EP, which have a completely unique structure. RFIO2 is an extension of the RFIO protocol and allows users to use newly introduced features, such as unit signals (repeater), for selected features. This protocol is fully compatible with the previous version of the protocol (RFIO).

Available frequency for individual territories:

865.15 MHz India

868.1 MHz Russia

868.5 MHz EU, Ukraine, Middle East

916 MHz Australia, New Zealand, America, Israel













Benefits of RFIO:

- Communication is low-energy and reliably transfers small data packets.
- Fees or licenses are not required.
- No overlapping of communication space with unaddressed commands.
- Frequency used does not interfere with Wi-Fi/Bluetooth devices.
- Setting communication between components is not conditional on working with a computer or system.

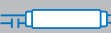
Benefits of RFIO2:

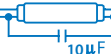
- Products labeled as “RFIO2” will allow newly set selected components such as unit signals (repeaters).
- For components, you can easily update FW using the RFAF/USB service device.
- Enables communication with RFMD-100 and RFWD-100.
- Data transfer between wireless components takes place in such a way that other receivers within range can help transfer the information (packet) to a remote receiver that is out of reach. It is possible to cover large-scale objects (real estate) and also increase the reliability of transmission in more demanding buildings.
- Backward compatibility with RFIO elements is retained.

Explanations

	El. bulbs loads: el. bulb, halogen light	(R)		Elektronic ballasts for fluorescent	(L)
	Dimmer with defined load: R - resistive, L - inductive, C - capacitive			Inductive loads (transformers): feromagnetic and toroid transformers for lights with various voltage.	
	Fluorescent light: fluorescent lights uncompensated			Switch: switch - control contact of various device	
	Fluorescent light: fluorescent light compensated in series			Button: control button	
	Fluorescent light: fluorescent light compensated in parallel			Control module: analog control module 0 - 10 V	
	Fluorescent light: fluorescent light economical			Motor	

Category of use	Typical use
AC current, $\cos\phi = P/S$ (-)	
AC-1	Non-inductive or slightly inductive load, resistance furnace. Includes all appliances supplied by AC current with power factor ($\cos\phi$) ≥ 0.95 . Examples of usage: resistance furnace, industrial loads.
AC-2	Motors with slip-ring armature, switching off.
AC-3	Motors with short-circuit armature, motor switching when in operation. This category applies to switching off motors with short-circuit armature while in operation. While switching, contactor switches current which is 5 up to 7 times rated current of motor.
AC-5a	Switching of electrical gas-filled lights, fluorescent lights.
AC-5b	El. bulb switching. Enables low contact loading due to resistance of cold filament is many times smaller than the one of hot filament.
AC-6a	Switching of transformers.
AC-7b	Load of motors for home appliances.
AC-12	Switching of semiconductor loads with separation transformers.
AC-13	Switching of semiconductor loads with separation transformers.
AC-14	Switching of low electro-magnetic loads (max. 72 VA).
AC-15	Management of alternating electro-magnetic loads. This category applies to switching inductive loads with input for closed electro-magnetic circuit higher than 72 VA. Use: switching coils of contactors.
Note: Category AC 15 replaces formerly used category AC 11.	
DC current, $t = L/R$ (s)	
DC-1	Non-inductive or low inductive load, resistive furnaces.
DC-3	Shunt motors: start-up, braking by backset, reversion, resistive braking.
DC-5	Series motor: start-up, braking by backset, reversion, resistive braking.
DC-12	Management of resistive loads and fixed loads with insulation by opto-electric element.
DC-13	Switching of electromagnets.
DC-14	Switching of electromagnetic loads in circuits with limiting resistor.

How can you distinguish for which load is our product (relay) designated?



















Our company records this information on a products and also in our catalogue, instruction manual and other promotional and technical material (website etc.). It is important to realize that it is not always possible to point out load because of lack of information about the device (user cannot measure $\cos\phi$) or it is not possible because of inconstancy of parameters of switched device. Manufacturer of relays records always guaranteed parameters in ideal conditions which are done by a norm (temperature, pressure, humidity, etc.) and reality can be in a lot of cases different. Category of use (classification) of a particular relay is done by material of output contacts.

Basic types of materials which are used for production of contacts for high-performance relay are:



















- AgCd – suitable for switching ohmic loads. Before of harmfulness of Cd, this type of contact is remitted.
- AgNi – designated for switching resistive loads, good quality switching and conducting (contact doesn't oxidate) small currents/voltages, it is not designated for surge currents and loads with inductive component.
- AgSn or AgSnO₂ – suitable for switching loads with inductive component, not suitable for switching small currents/voltages, it is more resistive to surge currents, suitable for DC voltage switching, less suitable for switching loads of ohmic type.
- Wf (wolfram)-special contact designated for switching surge currents with inductive component.
- with gold (AgNi/Au)- Used for "improving" contacts for low currents/ voltages, prevents oxidation.

Product loadability

RFJA-32B-SL; RFSA-62B-SL; RFSAI-62B-SL; RFSA-66M; RFSAI-11B-SL; RFSAI-62B-SL/TH; RFSW-62; RFSW-262; RFSTI-11B-SL; RFSAI-61B-SL













Load type	 cos φ ≥ 0.95 AC1	 AC2	 AC3	 AC5a without compensation	 AC5a with compensation	 AC5b	 AC6a	 AC7b	 AC12
Contact material AgSnO ₂ , Contact 8 A	250 V/8 A	250 V/2,5 A	250 V/1,5 A	230 V/1,5 A (345 VA)	230 V/1,5 A (345 VA) up to max input C=14uF	250 W	250 V/2 A	250 V/1 A	250 V/1 A
Load type	 AC13	 AC14	 AC15	 DC1	 DC3	 DC5	 DC12	 DC13	 DC14
Contact material AgSnO ₂ , Contact 8 A	250V/3 A	250 V/3 A	250 V/3 A	30 V/4 A	24 V/2 A	24 V/1,5 A	24 V/4 A	24 V/1 A	24 V/1 A

RFSA-61M; RFSC-61N; RFSA-61MI; RFSA-61B; RFUS-61**

Load type	 cos φ ≥ 0.95 AC1	 AC2	 AC3	 AC5a without compensation	 AC5a with compensation	 AC5b	 AC6a	 AC7b	 AC12
Contact material AgSnO ₂ , Contact 16 A	250 V/16 A	250 V/3 A	250 V/2 A	230 V/3 A (690 VA)	230 V/3 A (690 VA) up to max input C=14uF	1000 W	x	250 V/3 A	250 V/10 A
Load type	 AC13	 AC14	 AC15	 DC1	 DC3	 DC5	 DC12	 DC13	 DC14
Contact material AgSnO ₂ , Contact 16 A	250 V/6 A	250 V/6 A	250 V/6 A	24 V/8 A	24 V/3 A	24 V/2 A	24 V/6 A	24 V/2 A	x

** RFUS-61 - AC1=250 V/12 A

Load capacity of dimmers Wireless

	LED bulb		LED spot lights			LED panels		LED / RGB strip					
	DLB-E27-806-2K7	DLB-E27-806-5K	DLSL-GU10-350-3K	LSL-GU10-350-3K	LSL-GU10-350-5K	LP-6060-3K	LP-6060-6K	LED strip 7.2W	LED strip 14.4W	LED strip 19.2W	LED strip 28.8W	RGB strip 7.2W	RGB strip 14.4W
													
	number	number	number	number	number	number	number	number	number	number	number	number	number
RFDC-71N	✓ 21	✓ 21	✓ 45	✓ 25	✓ -	- -	- -	- -	- -	- -	- -	- -	- -
RFDEL-71B-SL	✓ 11	✓ 11	✓ 25	✓ 13	✓ 13	- -	- -	- -	- -	- -	- -	- -	- -
RFDA-73M/RGB	- -	- -	- -	- -	- -	- -	- -	✓ 3x8m	✓ 3x4m	✓ 3x3m	✓ 3x2m	✓ 20m	✓ 10m
RFDAI-32B-SL	- -	- -	- -	- -	- -	✓ 50	✓ 50	- -	- -	- -	- -	- -	- -

WARNING!

May lead to different results based on the state of network cable length and other factors.

This table contains the results of tests that were conducted internally and therefore is ONLY for customers only informative. The products were tested in test laboratories ELKO EP, and therefore the company assumes no responsibility for any imitation test environment.

Inductive and capacitive loads must not be connected simultaneously!

Load capacity:

* Due to the huge amount of type of light sources, the maximum load depends on internal construction of dimmable LED and ESL bulbs and their power factor cos φ, capacity for power factor cos φ=1. The power factor of dimmable LEDs and ESL bulbs ranges from cos φ= 0.95 up to 0.4. An approximate value of maximum load may be obtained by multiplying the load capacity of the dimmer by the power factor of the connected light source.

Pairing controllers with iNELS Wireless devices

There are different types of pairing according to the factory version of the driver. Due to technological advances, which are inevitable even in our products, you can have controllers with or without a pairing button. You can identify the controller with the pairing button by the mark  on the print on the back of the instrument panel and the physical presence of the pairing button on the controller.

To position the pairing buttons on your controllers:

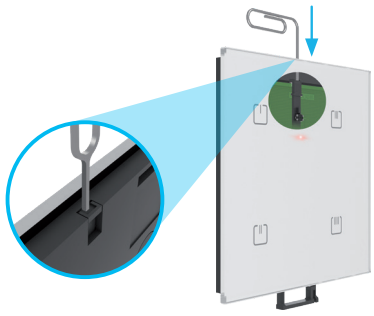

RFGB (both round and sharp versions):
Pressing on the upper control mandrel (paper clip, screwdriver) will eject the battery and the pairing button is released.

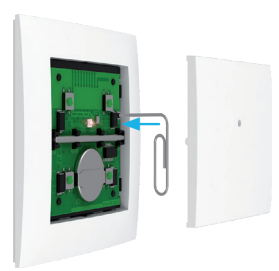

RFWB:
By removing the controller flap, the pairing button is accessed.

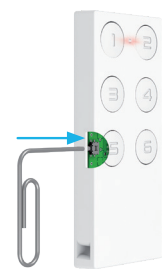

RF Key
It is located on the side near the button number 5.

A To assign a controller using the pairing button

Hold the pairing button for 1 second to put the controller into pairing mode – the red LED indicates with a short flash. Next, hold the PROG button on the device you want to control for 1s, 2 sec or 3 s (see **Tab 1** **PROG button modes**) Next, continue setting the functions (1 to 6) by pressing the appropriate button on the controller with the appropriate number of presses (see **Tab 2**). Finish programming by briefly pressing the PROG button on the device and briefly pressing the pairing button on the controller. We recommend that you first enter the controller into pairing mode and then the device. Putting the controller and the device into pairing mode is signaled by a red LED with a short blink.

Press (1s), Short press (>1s), Long press (1s >)

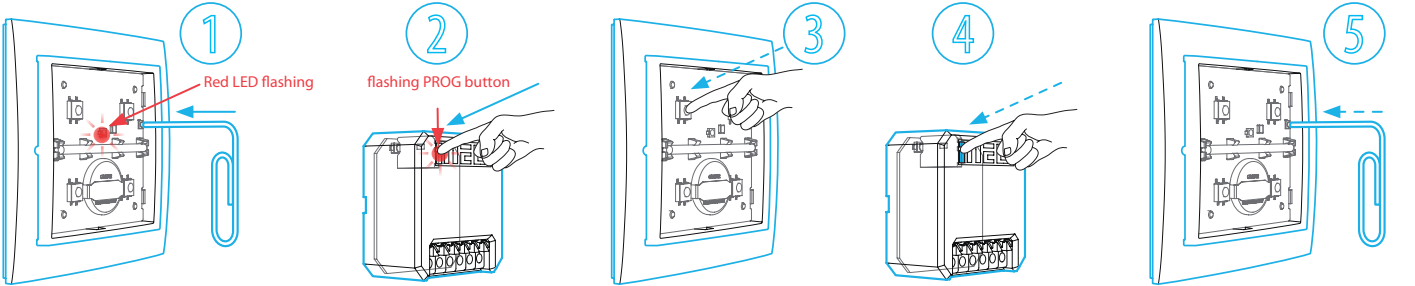

Press (1s) of the pairing button

Long press (1s >) of the PROG button (see. **Tab 1**)

Short press (>1s) of the selected button on the controller (number of presses = function)

Short press (>1s) of the PROG button to close

Short press (>1s) of the pairing button to exit the pairing mode

Controller = transmitter (i.e. RFGB, RFWB, RFKEY, etc.)

Device = receiver (e.g. RFSAx, RFIM, RFSG or RFDELxx etc.)

Assign a controller without a pairing button

Procedures without a pairing button are used to assign older controls to devices, and two pairing options are possible, depending on the version of the device. This is a pairing without putting into the so-called „pairing“ „Compatibility Mode“ or with the introduction to „Compatibility Mode“ mode (the oldest possible version).

Fast flashing:
The controller is in the state: Pairing in Compatibility Mode (**VRK**)

•••••

Short double flashes:
The driver is in the state: Pairing without compatibility mode (**BRK**)

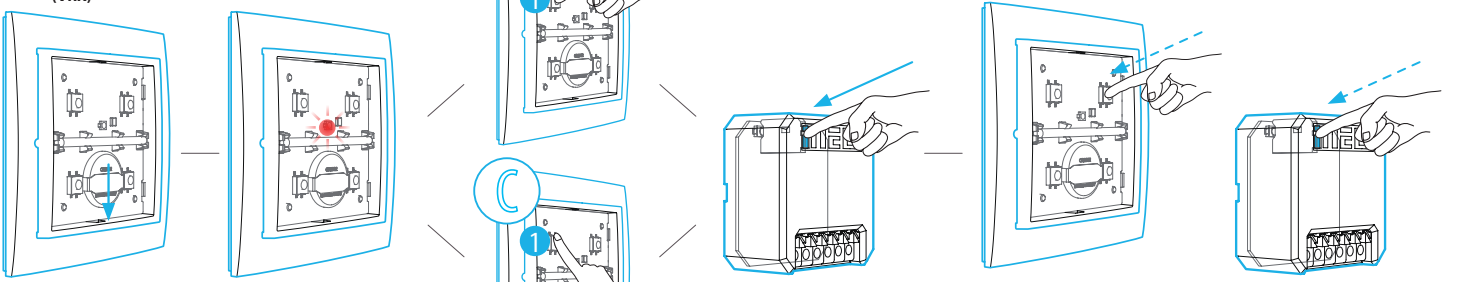

Removing and inserting the battery to activate the default state

Long press (1s >) of the PROG button (see. **Tab 1**)

Short press (>1s) of the selected button on the controller (number of presses = function)

Short press (>1s) of the PROG button to exit the programming mode.

B Pairing without compatibility mode

First, insert the battery into the controller. If the battery has already been inserted into the controller, remove it for at least 5 s to restore it to its default state. After inserting the battery, while the red LED is lit (3 s), press and hold 1 until the controller starts to indicate the driver mode by briefly flashing the LED. Then release the button to make the controller ready for pairing. Next, hold down the PROG button on the device you want to control for 1, 2 or 3 s (see **Tab 1**) continue to set functions 1 to 6 by pressing the appropriate button on the controller with the appropriate number of presses (see **Tab 2**). Finish programming by briefly pressing the PROG button on the device and removing and reinserting the battery into the controller.

C Pairing in compatibility mode

To pair the oldest versions of devices with drivers, it is necessary to switch the driver to Compatibility Mode. Remove the battery from the controller 5 s. After inserting the battery, the red LED is on for 3 s, press and hold 1 and 2 at the same time and keep them pressed until the controller signals the transition to Pairing in compatibility mode by flashing rapidly. Then the buttons must be released. The controller, which is in Compatibility Mode, is ready for pairing, so you only need to put the device into pairing mode. 1 s, 2 s or 3 s (depending on type see. table Modes of the PROG button) and continue setting functions 1 to 6 by pressing the appropriate button on the controller with the appropriate number of presses according to the manual of the device. Finish programming by briefly pressing the PROG button.

Switching between 1 and 2 modes also works the other way around, so you can switch back to Pairing without compatibility mode (transition indicator – double flash).

Table 1) Modes of the PROG button on the devices

Applies to:	Applies to: Entering pairing mode (Step 2)	Clearing channel/ button memory	Clear the memory of an entire device
RFSA-11B, RFSAI-11B-SL, RFSA-61B, RFSA-61B-SL, RFSA-61M, RFSA-61MI, RFSA-66M, RFSA-66MI, RFSC-61, RFUS-61, RFDA-11B, RFDEL-71B, RFDEL-71M, RFDEL-76M, RFDALI-04B, RFDALI-32B, RFDA-73M/RGB, RFDSC-71N	1 s	5 s	8 s
RFSAI-62B-SL, RFSA-62B, RFSAI-62BRFSW-62, RFSW-262, RFDW-71, RFDW-271	3 s	7 s	11 s
RFDAC-71B	2 s	5 s	10 s

Clear the memory of the button

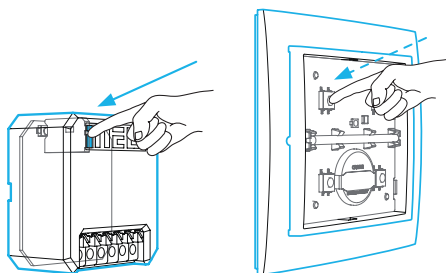

To clear an already paired channel to a button on the controller, press the PROG on the device for a period of time of 5 s or 7 s (see **Tab 1**). Clear the memory of the button and press the appropriate button on the controller that you want to unpair. After this step, it returns to its working state.

Clear the memory of the whole device

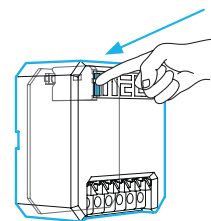

If you want to clear the memory of the whole device (unpair all buttons or delete all channels at once, press the PROG button on the device for 8/10/11 s according to the type of device (see. Tab 1). Clearing the memory of the entire device. The device remains in pairing mode.

DRIVER DEVELOPMENT AXIS











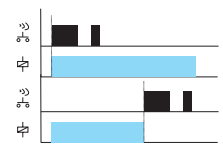
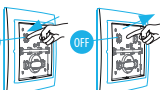
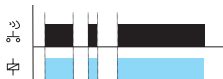





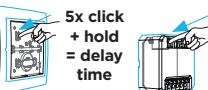
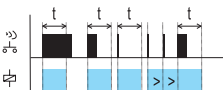

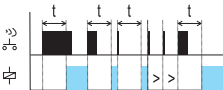

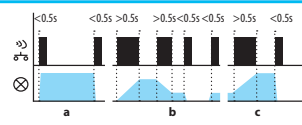

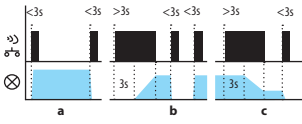

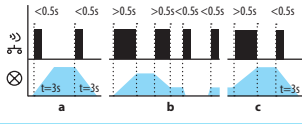

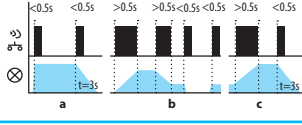
Please note:

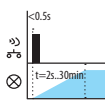
If you are pairing older versions of drivers or features with each other, it is not possible to clearly determine whether you need to use Compatibility Mode for pairing or not. Therefore, you need to try both ways.

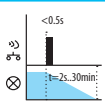
RF Key/W and RF Key/B key fobs and other drivers of the oldest possible version can no longer be paired with devices that have radio wavelet markings on the PROG button. RFSAI-62-SL, RFSA-62B, RFSAI-62B and RFDAC-71B units have a different pairing method. Always follow the instructions for the devices.

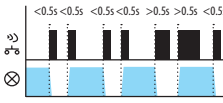
Table 2) Programming of feature functions

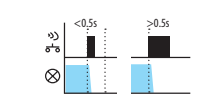
Single function - RFSA-11B-SL		
Assign a function	Feature description	Graph
 <p>1x click</p>	<p>Function button ON/OFF The output contact closes by pressing one button position, and opens by releasing the button.</p>	
It is a single-function relay, so when programming the ON function on the upper pusher, the OFF function is assigned to the button below it automatically		
Spínací prvky multifunkční - RFSA-61B, RFSA-62B-SL, RFSA-61M, RFSA-66M, RFSAI-62B-SL, RFSC-61N, RFUS-61		
 <p>1x click</p>	<p>Function 1 - button The output contact will be closed by pressing the button and opened by releasing the button.</p>	
 <p>2x click</p>	<p>Function 2 - switch on The output contact will be closed by pressing the button.</p>	
 <p>3x click</p>	<p>Function 3 - switch off The output contact will be opened by pressing the button.</p>	
 <p>4x click</p>	<p>Function 4 - impulse relay The output contact will be switched to the opposite position by each press of the button. If the contact was closed, it will be opened and vice versa.</p>	
 <p>5x click + hold = delay time 5 s hold</p>	<p>Function 5 - delayed off The output contact will be closed by pressing the button and opened after the set time interval has elapsed. $t = 2\text{ s} - 60\text{ min}$.</p>	
 <p>6x click + hold = delay time 6 s hold</p>	<p>Function 6 - delayed on The output contact will be opened by pressing the button and closed after the set time interval has elapsed. $t = 2\text{ s} - 60\text{ min}$.</p>	
The timing function (5 and 6) is performed by combining multiple presses and tracking the time for which we want to activate the delayed return or start (see. Manual for switching devices).		
Stmívací prvky multifunkční RFDA-73M/RGB, RFDEL-71B-SL, RFDEL-71M, RFDCS-71N, RFDA-71B, RFDW-71		
 <p>1x click short + long = scene 1</p>	<p>Light scene function 1 The brightness level is saved in the memory, and pressing the button shortly later will switch the light on/off to this intensity. It is possible to readjust the change in intensity at any time by a long press of the programmed button. The actuator remembers the adjusted value even after disconnecting from the power supply.</p>	
 <p>2x click short + long = scene 2</p>	<p>Light scene function 2 The brightness level is saved in the memory, and pressing the button shortly later will switch the light on/off to this intensity. It is possible to readjust the change in intensity at any time by pressing the programmed button for over 3 s. The actuator remembers the adjusted value even after disconnecting from the power supply.</p>	
 <p>3x click short + long = scene 3</p>	<p>Light scene function 3 The brightness level is saved in the memory, and pressing the button shortly later will switch the light on/off to this intensity. It is possible to readjust the change in intensity at any time by a long press of the programmed button. The actuator remembers the adjusted value even after disconnecting from the power supply.</p>	
 <p>4x click short + long = scene 4</p>	<p>Light scene function 4 The brightness level is saved in the memory, and pressing the button shortly later will switch the light on/off to this intensity. It is possible to readjust the change in intensity at any time by a long press of the programmed button. The actuator remembers the adjusted value even after disconnecting from the power supply.</p>	
 <p>5x Click + hold = time 5s hold</p>	<p>Function sunrise After pressing the programmed button, the light begins to illuminate in the programmed time interval in a range of 2 seconds to 30 minutes.</p>	
 <p>6x Click + hold = time 6s hold</p>	<p>Function sunset After pressing the programmed button, the light begins to dim in the programmed time interval in a range of 2 seconds to 30 minutes.</p>	
 <p>7x click</p>	<p>Function ON / OFF If the light is switched off, pressing the programmed button will switch it on. If the light is switched on, pressing the programmed button will switch it off.</p>	
 <p>8x click</p>	<p>Function switch OFF The dimmer output switches off by pressing the button.</p>	

The sunrise and sunset function is performed by combining multiple presses and tracking the time for which we want to activate the delayed return or start (see. Manual for switching devices).



1) Surface mounted

Wall mounted or in an installation box with spacing of 65 mm.

- | | | |
|-------------|-------------|----------|
| RFWB-20/G | RFGB-40B/MT | RFGB-220 |
| RFWB-40/G | RFGB-40W/MT | RFGB-240 |
| RFWB-40G/MT | RFCT-10/G | |
| RFGB-20 | RFCT-50/G | |
| RFGB-40 | RFCT-150/G | |

2) Flush mounted

- | | |
|------------|-----------|
| RF Touch-2 | RFSW-62/S |
| RFDW-71 | |
| RFDW-271 | |
| RFGS-30/S | |

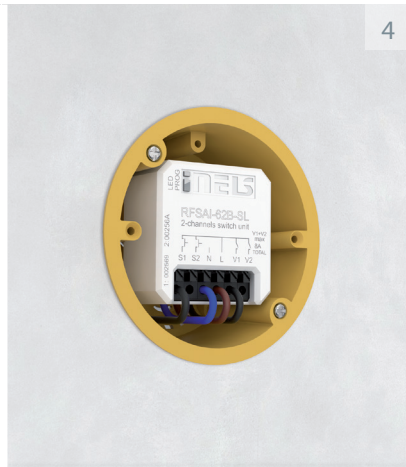
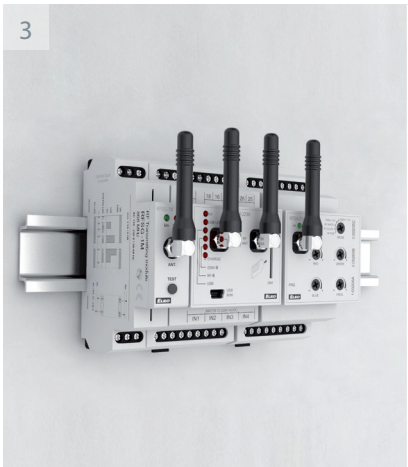

3) DIN Rail mounted

On DIN rail according to EN 60715.

- | | |
|--------------|-----------|
| RFSG-1M | RFSA-61M |
| RFDA-73M/RGB | RFSA-66M |
| RFDEL-71M | RFSA-66MI |
| RFSA-266M | RFSA-61MI |
| | RFDEL-76M |

4) Flush mounted (BOX)

- | | |
|-----------------|-----------------|
| RFIM-40B-BP-SL | RFSAI-62B-SL |
| RFIM-40B-230-SL | RFSAI-61BPF-SL |
| RFDALI-32B-SL | RFJA-32B-SL |
| RFDALI-04B-SL | RFSTI-11B-SL |
| RFDEL-71B-SL | RFSAI-161B |
| RFSAI-11B-SL | RFSTI-111B |
| RFSA-61B | RFSAI-62B-SL/MT |



5) Mounted into the cover of appliance

- | | | |
|---------------|--------------|-----------------|
| RFDALI-32B-SL | RFSAI-62B-SL | RFSTI-111B |
| RFDALI-04B-SL | RFSAI-BPF-SL | RFSAI-62B-SL/MT |
| RFDEL-71B-SL | RFJA-32B-SL | |
| RFSAI-11B-SL | RFSTI-11B-SL | |
| RFSA-61B | RFSAI-161B | |

6) Surface mounted

- | | |
|----------|----------|
| RFSOU-1 | RFWD-100 |
| RFUS-61 | RFOWB-20 |
| RFTM-100 | RFMD-200 |
| RFSF-100 | RFSLT-S3 |
| RFMD-100 | |

Product dimension

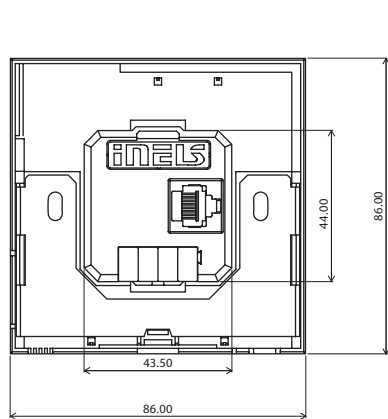

RF Touch 2

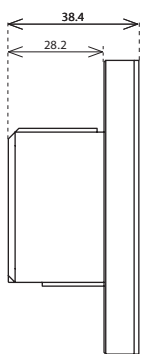

Surface-mounted

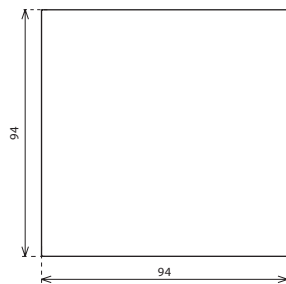

Flush-mounted

Surface-mounted

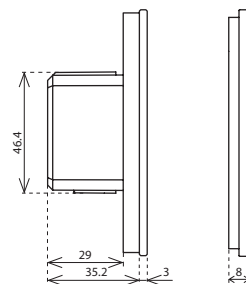

RFSW-62
RFDW-71

RFGB-20/G
RFGB-40/G
RFWB-40G/MT

RFGB-40B/MT
RFGB-40W/MT

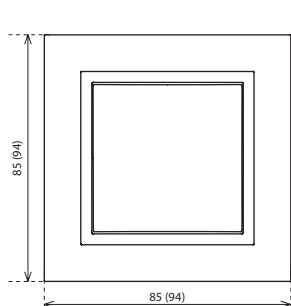

Frame dimensions are given (for metal frames, glass, wood, granite)

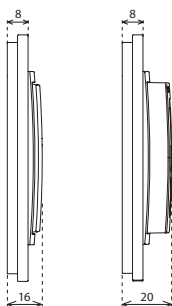

RFWB-20/G
RFWB-40/G
RFWB-40/MT

RFTC-10/G
RFTC-50/G
RFTC-150/G

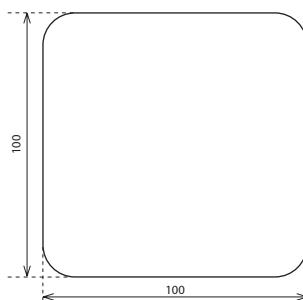

Flush-mounted

Surface-mounted

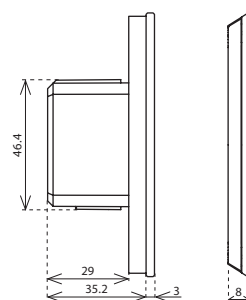

RFSW-262
RFDW-271
RFGS-30/S
RFSW-62/S

RFGB-220/G
RFGB-240/G

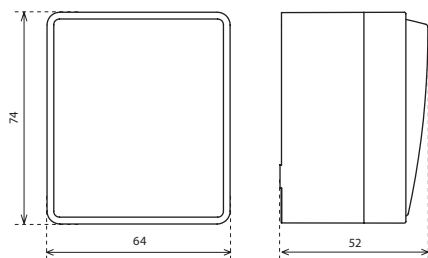

RFOWB-20

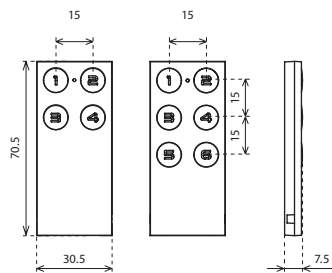
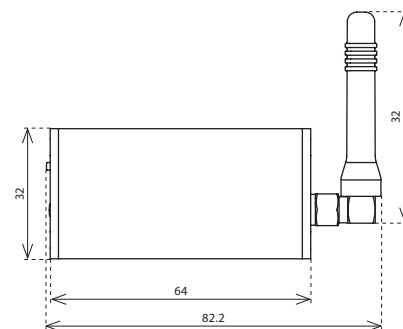
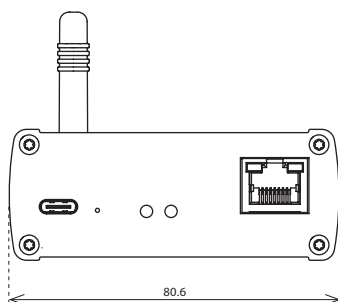

RF KEY-40

RF KEY-60

BOX

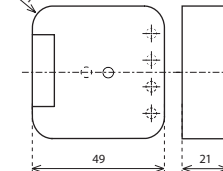

RFSA-61B
RFSA-161B
RFSTI-111B
RFDEL-71M

BOX

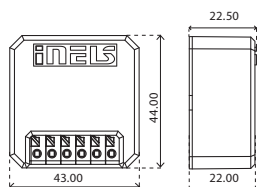

- RFIM-40B-230-SL
- RFDALI-32B-SL
- RFDALI-04B-SL
- RFSTI-11B-SL
- RFSAI-11B-SL
- RFDEL-71B-SL
- RFDEL-71B-SL/MT
- RFJA-32B-SL
- RFSAI-62B-SL
- RFSAI-61BPF-SL
- RFSAI-61B-SL
- RFSAI-62B-SL/MT
- RFIM-40B-BP-SL

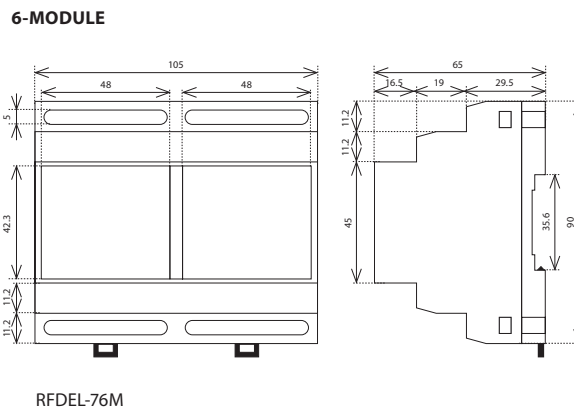
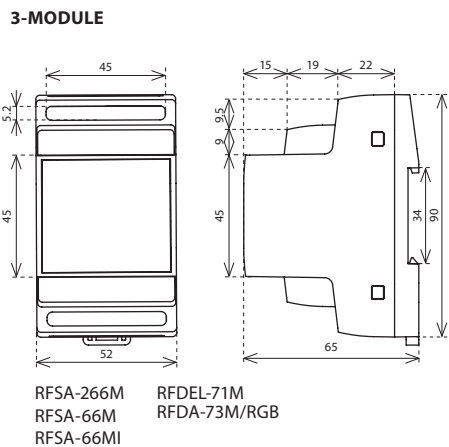
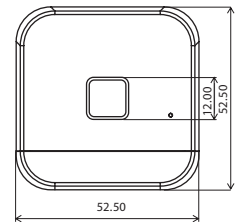
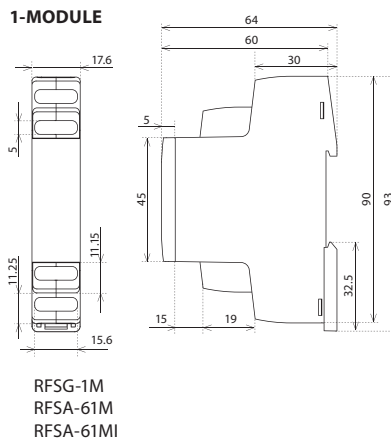
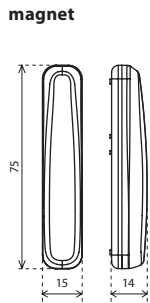
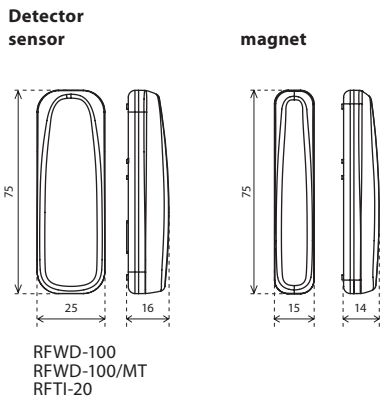
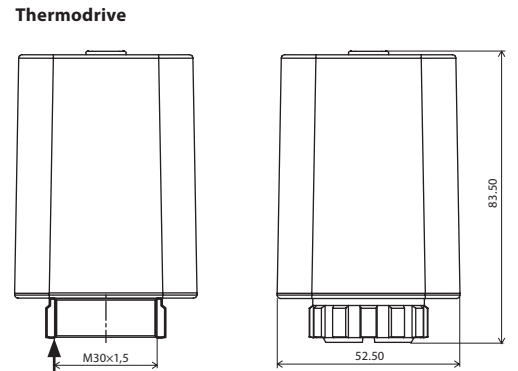
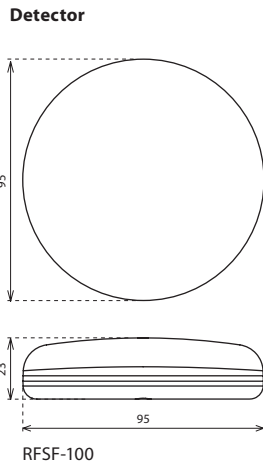
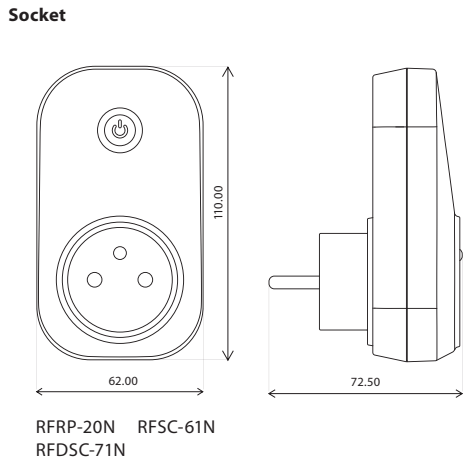
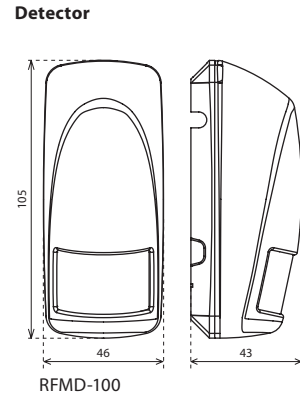
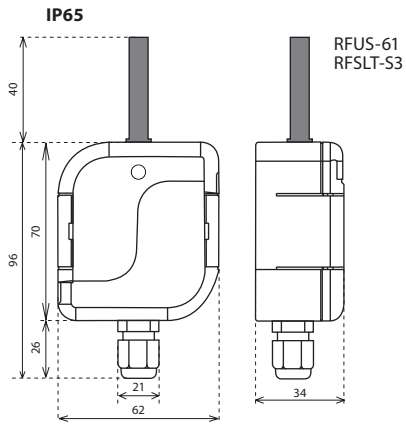
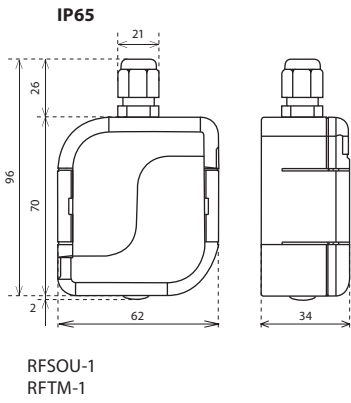

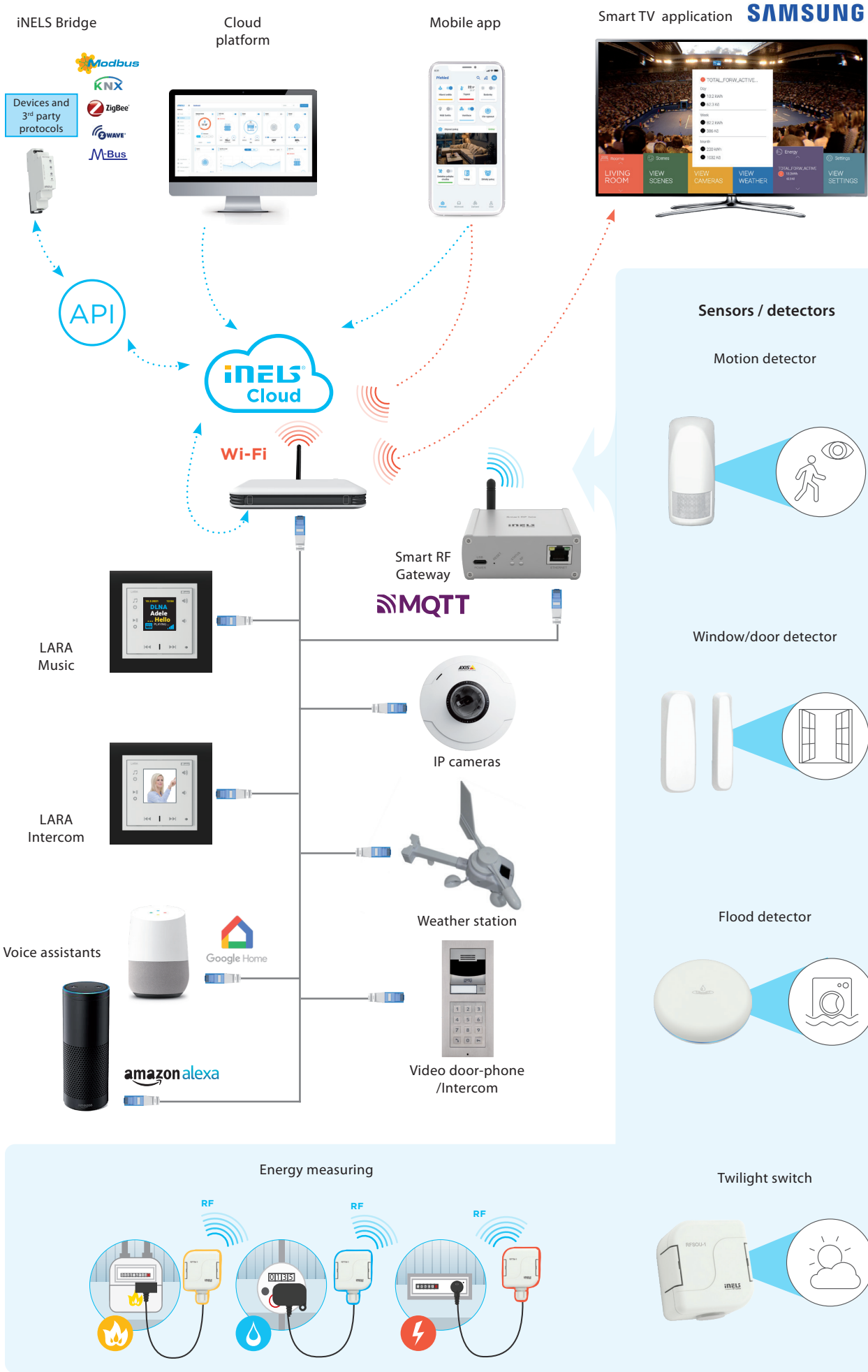

Actuators

Controllers

Switching socket

Universal dimmer R-L-C-LED-ESL

Switch unit for shutters

Thermovalve

Switch unit 6-channels

DALI controller

Switch unit for outdoor use



On wall button controller



Glass touch controller



Glass touch with dimmer



Key fob



Input contacts converter



Outdoor controller



Control unit



Temperature controller



A series of horizontal blue lines for writing, spanning the width of the page.





● **Headquarters**

ELKO EP Holding SE, Czech Republic

● **Europe**

ELKO EP Balkan d.o.o
ELKO EP Bulgaria OOD
ELKO EP Germany GmbH
ELKO EP Hungary Kft.
ELKO EP POLAND Sp. z o.o.
ELKO EP SLOVAKIA, s.r.o.
ELKO EP UK Ltd.
ELKO EP UKRAINE LLC

● **Africa & Middle East**

ELKO EP Egypt LLC
ELKO EP Kuwait Ltd.
ELKO EP MEA LLC
ELKO EP Saudi Arabia Ltd.
ELKO EP South Africa PTY Ltd.

● **America**

ELKO EP North America LLC



ELKO EP, s.r.o. | Palackeho 493 | 769 01 Holesov, Vsetuly | Czech Republic
phone: +420 573 514 221 | fax: +420 573 514 227 | elko@elkoep.com | www.elkoep.com

Published: 03/2025 | Modifications or amendments reserved | © Copyright ELKO EP, s.r.o. | 1st edition